

Electronic timers

Product group picture

1



Electronic timers

Table of contents

Electronic timers

Electronic timers	12
Type selection	13
Approvals and marks	14
CT-D range	16
Benefits and advantages	17
Ordering details	18
Connection diagrams	19
Technical data	20
Technical diagrams, Wiring notes, Dimensional drawings	22
CT-E range	24
Benefits and advantages	25
Ordering details	26
Connection diagrams	28
Connection diagrams, Technical diagrams	29
Technical data	30
Wiring notes, Dimensional drawings	32
CT-S range	34
Benefits and advantages	35
Ordering details - multifunctional	37
Ordering details - singlefunctional	38
Ordering details - Accessories	39
Connection diagrams	40
Technical data	42
Technical diagrams	45
Wiring notes, Dimensional drawings	46
Electronic timers	47
Timing functions	47

Electronic timers

Type selection



CT-D range in modular DIN rail housing

- Time ranges: 7 (0.05 s - 100 h)
- CT-SDD, CT-SAD: (0.05 s - 10 min)
- Wide and multi ranges of control supply voltage
- 1 or 2 c/o contacts
- CT-SDD, CT-SAD: 2 n/o contacts
- Control inputs: voltage-related triggering, polarized, capable of switching a parallel load

CT-E the economic range

- Multifunction devices: 8 (0.05 s - 100 h)
- Single-function devices: 0.05-1 s, 0.1-10 s, 0.3-30 s, 3-300 s, 0.3-300 min
- Wide, single and dual ranges of control supply voltage
- 1 c/o contact
- CT-SDE: 1 n/o contact and 1 n/c contact
- CT-MKE, CT-EKE, CT-AKE: 1 thyristor
- voltage-related triggering, polarized
- CT-MFE, CT-AHE, CT-AWE: with auxiliary voltage

CT-S the high-performance range









- 10 (0.05 s - 300 h)
- CT-ARS, CT-SDS: 7 (0.05 s - 10 min)
- Wide, single and multi ranges of control supply voltage
- 1 or 2 c/o contacts
- CT-MVS.21, CT-MFS, CT-MBS: 2nd c/o contact selectable as inst. contact
- CT-SDS: 2 n/o contacts
- voltage-related triggering, non-polarized, capable of switching a parallel load
- CT-MFS, CT-MBS, CT-AHS: volt-free triggering

		multifunctional	single-functional	multifunctional	single-functional	multifunctional	single-functional
Timing function		CT-D		CT-E		CT-S	
☒ ON-delay		CT-MFD	CT-ERD	CT-MFE, CT-MKE	CT-ERE, CT-EKE	CT-MVS, CT-MFS, CT-MBS, CT-WBS	CT-ERS
■ OFF-delay		CT-MFD	CT-AHD	CT-MFE	CT-AHE, CT-ARE, CT-AKE	CT-MVS, CT-MFS, CT-MBS	CT-APS, CT-AHS, CT-ARS
☒■ ON- and OFF-delay						CT-MVS, CT-MXS, CT-MFS, CT-MBS	
1☒ Impulse-ON		CT-MFD	CT-VWD	CT-MFE, CT-MKE	CT-VWE	CT-MVS, CT-MFS, CT-MBS, CT-WBS	
1■ Impulse-OFF		CT-MFD			CT-AWE	CT-MVS, CT-MFS, CT-MBS	
1☒■ Impulse-ON and OFF						CT-MXS	
☒☒ Flasher starting with ON		CT-MFD	CT-EBD	CT-MFE, CT-MKE		CT-MFS, CT-MBS, CT-WBS	
☒■ Flasher starting with OFF		CT-MFD		CT-MFE, CT-MKE	CT-EBE	CT-MFS, CT-MBS, CT-WBS	
☒☒ Flasher starting with ON or OFF						CT-MVS	
☒☒ Pulse generator starting with ON or OFF			CT-TGD			CT-MXS	
☒☒ Pulse former		CT-MFD		CT-MFE		CT-MVS, CT-MFS, CT-MBS	
△ Star-delta change-over			CT-SDD, CT-SAD				CT-SDS
△1☒ Star-delta change-over with impulse					CT-SDE	CT-MVS.2x, CT-MFS, CT-MBS	
△☒ Star-delta change-over twice ON-delayed					CT-YDE		
☒+ ☒1☒ ■1☒ ☐ further functions (depending on device)						CT-MVS, CT-MXS, CT-MFS, CT-MBS, CT-WBS	

A detailed explanation of the different timing functions can be found at "Timing functions" on page 47.

Electronic timers

Approvals and marks

		CT-D	CT-E	CT-S
	UL508, CAN/CA C22.2 No. 14	All	All	All
	CB Scheme	All except: CT-MFD.21, CT-ERD.22, CT-AHD.22, CT-TGD.22, CT-SDD.22, CT-SAD.22	All except: CT-MKE, CT-EKE, CT-AKE	All
	EAC	All	All	All
	CCC	All	All except: CT-MKE, CT-EKE, CT-AKE	All
	RMRS	All except: CT-SDD.22, CT-SAD.22	All	All
	Germanischer Lloyd	-	All	All available Pending for: CT-ARS.11
	Communauté Européenne	All	All	All
	RCM	All available Pending for: CT-MFD.21, CT-ERD.22, CT-AHD.22, CT-TGD.22, CT-SDD.22, CT-SAD.22	All	All

1

CT-D range

Product group picture

1



CT-D range

Table of contents

CT-D Range

CT-D range	16
Benefits and advantages	17
Ordering details	18
Connection diagrams	19
Technical data	20
Technical diagrams, Wiring notes, Dimensional drawings	22

CT-D range

Benefits and advantages

1

Characteristics

- Diversity:
 - 2 multifunction timers
 - 10 single-function timers
- Control supply voltages:
 - Wide range: 12-240 V AC/DC
 - Multi range: 24-48 V DC, 24-240 V AC
- 7 time ranges from 0.05 s to 100 h or
4 time ranges from 0.05 s to 10 min
- Width of only 17.5 mm
- Light-grey housing in RAL 7035
- Devices with:
 - 1 c/o contact (250 V / 6 A) or 2 c/o contacts (250 V / 5 A)
 Control input: voltage-related triggering, polarized, capable of switching parallel loads
- Approvals / Marks (partly pending, details see "Approvals and marks" on page 14)



¹⁾ Only for devices with 1 c/o (SPDT) contact

Benefits

Direct reading scales ①

Direct setting of the time delay without any additional calculation provides accurate time delay adjustment.

LEDs for status indication ②

All actual operational states are displayed by front-face LEDs, thus simplifying commissioning and troubleshooting.

Switching currents

The CT-D range timers allow an output load of up to 6 A on devices with 1 c/o contact and up to 5 A on devices with 2 c/o contacts.

Connection terminals ③

Wide terminal spacing allows connection of wires: 2 x 1.5 mm² (2 x 16 AWG) with wire end ferrules or 2 x 2.5 mm² (2 x 14 AWG) without ferrules.

Width 17.5 mm ④

With their width of 17.5 mm only, the CT-D range timers are ideally suited for installation in distribution panels.

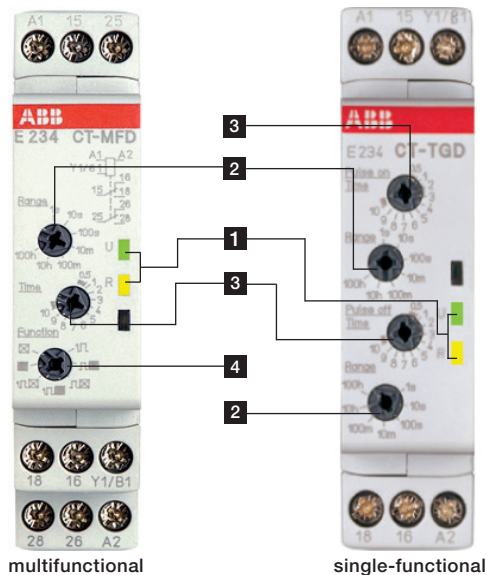

Operating controls

① LEDs for status indication

- U - green LED: control supply voltage applied
- timing
- R, R1, R2 - yellow LED: output relay energized

② Time range adjustment

③ Fine adjustment of the time delay

④ Preselection of the timing function

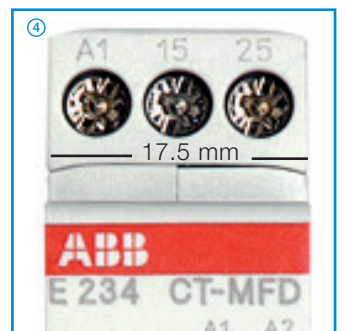
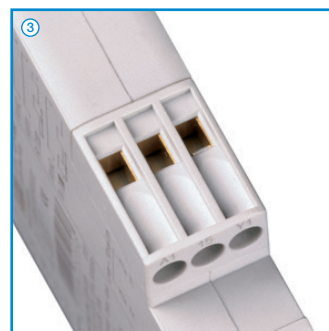
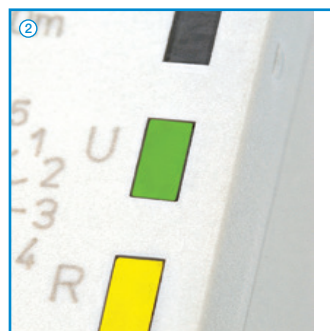
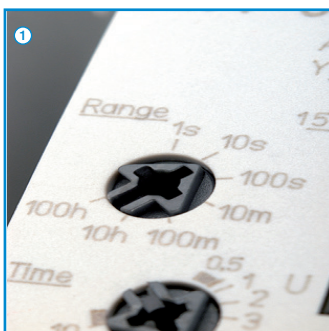

CT-D range

Ordering details



CT-MFD.12



CT-ERD.22

Description

The CT-D range in MDRC design with a width of only 17.5 mm fits into all domestic installation and distribution panels.

The CT-D range represents a link between industry and the installation types. For maximum flexibility in operation, 10 single-function as well as 2 multifunction devices with 7 timing functions are available. The devices offer 4 or 7 time ranges from 0.05 seconds up to 100 hours. Their wide input range allows the use in applications worldwide.

Ordering details

Timing function	Rated control supply voltage	Time ranges	Control input	Output	Type	Order code	Price	Weight
							1 pce	(1 pce) kg (lb)
Multi ¹⁾	24-240 V AC 24-48 V DC	7 (0.05 s - 100 h)	■	1 c/o	CT-MFD.12	1SVR500020R0000		0.060 (0.132)
Multi ¹⁾	12-240 V AC/DC	7 (0.05 s - 100 h)	■	2 c/o	CT-MFD.21	1SVR500020R1100		0.065 (0.143)
ON-delay			-	1 c/o	CT-ERD.12	1SVR500100R0000		0.060 (0.132)
			-	2 c/o	CT-ERD.22	1SVR500100R0100		0.065 (0.143)
OFF-delay		7 (0.05 s - 100 h)	■	1 c/o	CT-AHD.12	1SVR500110R0000		0.060 (0.132)
			■	2 c/o	CT-AHD.22	1SVR500110R0100		0.065 (0.143)
Impulse-ON	24-240 V AC 24-48 V DC		-		CT-VWD.12	1SVR500130R0000		0.060 (0.132)
Flasher starting with ON			-	1 c/o	CT-EBD.12	1SVR500150R0000		
Pulse generator		2x7 (0.05 s - 100 h)	■		CT-TGD.12 ²⁾	1SVR500160R0000		0.060 (0.132)
			■	2 c/o	CT-TGD.22 ²⁾	1SVR500160R0100		0.065 (0.143)
Star-delta change-over		4 (0.05 s - 10 min)	-		CT-SDD.22 ³⁾	1SVR500211R0100		0.065 (0.143)
			-	2 c/o	CT-SAD.22 ⁴⁾	1SVR500210R0100		

¹⁾ Functions: ON-delay, OFF-delay with auxiliary voltage, Impulse-ON, Impulse-OFF with auxiliary voltage, Flasher starting with ON, Flasher starting with OFF, Pulse former

²⁾ ON and OFF times adjustable independently: 2 x 7 time ranges 0.05 s - 100 h

³⁾ Transition time 50 ms fixed

⁴⁾ Transition time adjustable

■ Control input with voltage-related triggering
- no triggering

Synonyms

used expression	alternative expression(s)	used expression	alternative expression(s)
1 c/o contact	SPDT	voltage-related	wet / non-floating
2 c/o contacts	DPDT	volt-free	dry / floating



Further documentation CT-D electronic timers on www.abb.com

CT-D range

Connection diagrams

1

CT-MFD.21

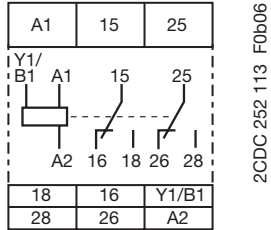

2CDC 252 113 F0b06

A1-A2 Supply: 12-240 V AC/DC
 A1-Y1/B1 Control input
 15-16/18 1. c/o contact
 25-26/28 2. c/o contact

CT-MFD.12

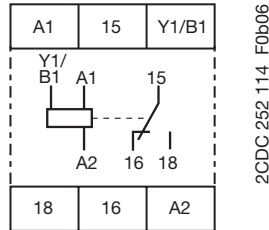

2CDC 252 114 F0b06

A1-A2 Supply: 24-48 V DC or 24-240 V AC
 A1-Y1/B1 Control input
 15-16/18 1. c/o contact

CT-ERD.22

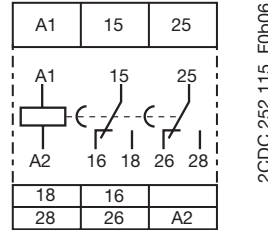

2CDC 252 115 F0b06

A1-A2 Supply: 24-48 V DC or 24-240 V AC
 15-16/18 1. c/o contact
 25-26/28 2. c/o contact

CT-ERD.12

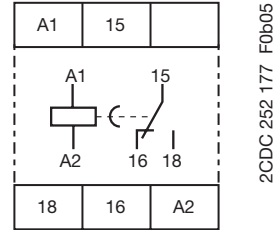

2CDC 252 177 F0b05

A1-A2 Supply: 24-48 V DC or 24-240 V AC
 15-16/18 1. c/o contact

CT-AHD.22

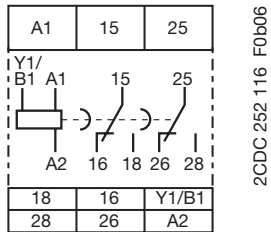

2CDC 252 116 F0b06

A1-A2 Supply: 24-48 V DC or 24-240 V AC
 A1-Y1/B1 Control input
 15-16/18 1. c/o contact
 25-26/28 2. c/o contact

CT-AHD.12

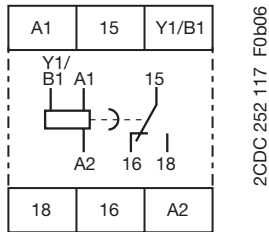

2CDC 252 117 F0b06

A1-A2 Supply: 24-48 V DC or 24-240 V AC
 A1-Y1/B1 Control input
 15-16/18 1. c/o contact

CT-VWD.12

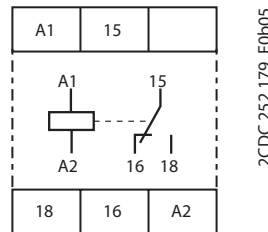

2CDC 252 179 F0b05

A1-A2 Supply: 24-48 V DC or 24-240 V AC
 15-16/18 1. c/o contact

CT-EBD.12

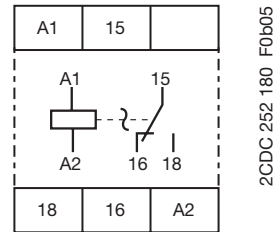

2CDC 252 180 F0b05

A1-A2 Supply: 24-48 V DC or 24-240 V AC
 15-16/18 1. c/o contact

CT-TGD.22

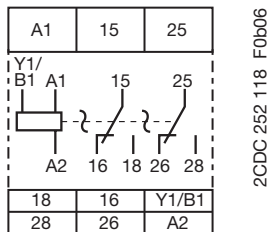

2CDC 252 118 F0b06

A1-A2 Supply: 24-48 V DC or 24-240 V AC
 A1-Y1/B1 Control input
 15-16/18 1. c/o contact
 25-26/28 2. c/o contact

CT-TGD.12

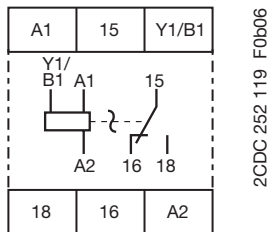

2CDC 252 119 F0b06

A1-A2 Supply: 24-48 V DC or 24-240 V AC
 A1-Y1/B1 Control input
 15-16/18 1. c/o contact

CT-SDD.22

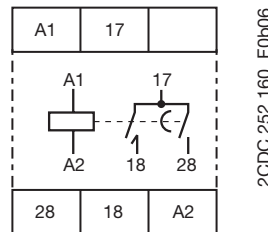

2CDC 252 160 F0b06

A1-A2 Supply: 24-48 V DC or 24-240 V AC
 17-18 1. n/o contact (star contactor)
 17-28 2. n/o contact (delta contactor)

CT-SAD.22

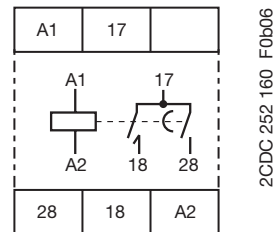



2CDC 252 160 F0b06

A1-A2 Supply: 24-48 V DC or 24-240 V AC
 17-18 1. n/o contact (star contactor)
 17-28 2. n/o contact (delta contactor)

CT-D range

Technical data

Data at $T_a = 25\text{ °C}$ and rated values, unless otherwise indicated

	CT-D with 1 c/o contact	CT-D with 2 c/o contacts	CT-MFD.21
Input circuit - Supply circuit			
Rated control supply voltage U_s	24-240 V AC / 24-48 V DC		12-240 V AC/DC
Rated control supply voltage U_s tolerance	-15...+10 %		
Rated frequency	DC or 50/60 Hz		
Frequency range AC	47-63 Hz		
Typical current / power consumption	see data sheet		
Power failure buffering time	min. 20 ms		
Release voltage	> 10 % of the minimum rated control supply voltage U_s		
Input circuit - Control circuit			
Control input, control function	A1-Y1/B1	start timing external	
Kind of triggering		voltage-related triggering	
Resistance to reverse polarity		yes	
Parallel load / polarized		yes / yes	
Maximum cable length to the control inputs		50 m - 100 pF/m	
Minimum control pulse length		20 ms	
Control voltage potential		see rated control supply voltage	
Current consumption of the control input		see data sheet	
Timing circuit			
Time ranges	7 time ranges 0.05 s - 100 h	1.) 0.05-1 s 2.) 0.5-10 s 3.) 5-100 s 4.) 0.5-10 min 5.) 5-100 min 6.) 0.5-10 h 7.) 5-100 h	
	4 time ranges 0.05 s - 10 min (CT-SDD, CT-SAD)	1.) 0.05-1 s 2.) 0.5-10 s 3.) 5-100 s 4.) 0.5-10 min	
Recovery time		< 50 ms	
Accuracy within the rated control supply voltage tolerance		$\Delta t < 0.005\ % / V$	
Accuracy within the temperature range		$\Delta t < 0.06\ % / \text{°C}$	
Repeat accuracy (constant parameters)		$\Delta t < \pm 0.5\ %$	
Setting accuracy of time delay	IEC/EN 61812-1	$\pm 10\ %$ of full-scale value	
Star-delta transition time	CT-SDD / CT-SAD	fixed 50 ms / adjustable: 20 ms, 30 ms, 40 ms, 50 ms, 60 ms, 80 ms or 100 ms	
Star-delta transition time tolerance	CT-SDD / CT-SAD	$\pm 3\ ms$	
Indication of operational states			
Control supply voltage / timing	U: green LED	 : control supply voltage applied  : timing	
Relay energized (1 c/o contact / 2 c/o contacts or inst. contact)	R: yellow LED	 : output relay energized	
Operating elements and controls			
Adjustment of the time range		front-face rotary switch, direct reading scales	
Fine adjustment of the time value		front-face potentiometer	
Preselection of the timing function at multifunction devices		front-face rotary switch, direct reading scales	
Adjustment of the transition time	CT-SAD	front-face potentiometer	
Output circuit			
Kind of output	15-16/18 15-16/18; 25-26/28 17-18; 17-28	Relay, 1 c/o contact - -	- Relay, 2 c/o contacts Relay, 2 n/o contacts (CT-SDD, CT-SAD)
Contact material		AgNi alloy, Cd free	
Rated operational voltage U_o		250 V	
Minimum switching voltage / minimum switching current		12 V / 100 mA	
Maximum switching voltage / maximum switching current		250 V AC / 6 A	
Rated operational current I_o (IEC/EN 60947-5-1)	AC-12 (resistive) at 230 V AC-15 (inductive) at 230 V DC-12 (resistive) at 24 V DC-13 (inductive) at 24 V	6 A 3 A 6 A 2 A	5 A 3 A 5 A 2 A
AC rating (UL 508)	utilization category (Control Circuit Rating Code) max. rated operational voltage	B 300 300 V AC	n/o: B 300 n/c: C 300
	Maximum continuous thermal current at B300	5 A	n/o: 5 A
	Maximum continuous thermal current at C300	-	n/c: 2.5 A
	max. making/breaking apparent power at B300	3600 VA / 360 VA	n/o: 3600/360 VA
	max. making/breaking apparent power at C300	-	n/c: 1800/180 VA
Mechanical lifetime		30 x 10 ⁶ switching cycles	
Electrical lifetime		0.1 x 10 ⁶ switching cycles	
Max. fuse rating to achieve short-circuit protection (IEC/EN 60947-5-1)	n/c contact n/o contact	6 A fast-acting 10 A fast-acting	6 A fast-acting

CT-D range

Technical data

1

		CT-D with 1 c/o contact	CT-D with 2 c/o contacts	CT-MFD.21
General data				
Mean time between failures (MTBF)		on request		
Duty time		100%		
Dimensions (W x H x D)		17.5 x 70 x 58 mm (0.69 x 2.76 x 2.28 in)	17.5 x 80 x 58 mm (0.69 x 3.15 x 2.28 in)	
Weight		see ordering details		
Mounting		DIN rail (IEC/EN 60715), snap-mounting without any tool		
Mounting position		any		
Minimum distance to other units	horizontal / vertical	no / no		
Degree of protection	housing / terminals	IP50 / IP20		
Electrical connection				
Wire size	fine-strand with(out) wire end ferrule	2 x 0.5-1.5 mm ² (2 x 20-16 AWG) 1 x 0.5-2.5 mm ² (1 x 20-14 AWG)		
	rigid	2 x 0.5-1.5 mm ² (2 x 20-16 AWG) 1 x 0.5-4 mm ² (1 x 20-12 AWG)		
Stripping length		7 mm (0.28 in)		
Tightening torque		0.5-0.8 Nm (4.43-7.08 lb.in)		
Environmental data				
Ambient temperature range	operation / storage	-20 ... +60 °C / -40 ... +85 °C		
Climatic class	IEC/EN 60068-2-30	3K3		
Relative humidity range		25-85%		
Shock (half-sine)	IEC/EN 60068-2-27	150 m/s ² , 11 ms		
Isolation data				
Rated impulse withstand voltage U _{imp} between all isolated circuits	IEC/EN 60664-1	type test: 4 kV; 1.2/50 µs		
Pollution category	IEC/EN 60664-1	3		
Overvoltage category	IEC/EN 60664-1	III		
Rated insulation voltage U _i	input circuit / output circuit	300 V		
	output circuit 1 / output circuit 2	not available	300 V	300 V
Basic insulation (IEC/EN 61140)	input circuit / output circuit	300 V		
Protective separation (IEC/EN 61140, EN 50178)	input circuit / output circuit	250 V		
Power-frequency withstand voltage test (test voltage)	between all isolated circuits	routine test: 2.5 kV; 50 Hz; 1 s type test: 2.5 kV; 50 Hz; 60 s		
Standards				
Product standard		IEC/EN 61812-1		
Low Voltage Directive		2006/95/EC		
EMC Directive		2004/108/EC		
RoHS Directive		2011/65/EC		
Electromagnetic compatibility				
Interference immunity to		IEC/EN 61000-6-1, IEC/EN 61000-6-2		
electrostatic discharge	IEC/EN 61000-4-2	Level 3 (6 kV / 8 kV)		
radiated, radio-frequency, electromagnetic field	IEC/EN 61000-4-3	Level 3 (10 V / m)		
electrical fast transient / burst	IEC/EN 61000-4-4	Level 3 (2 kV / 5 kHz)		
surge	IEC/EN 61000-4-5	Level 4 (2 kV L-L)		
conducted disturbances, induced by radio-frequency fields	IEC/EN 61000-4-6	Level 3 (10 V)		
Interference emission		IEC/EN 61000-6-3, IEC/EN 61000-6-4		
high-frequency radiated	IEC/CISPR 22, EN 55022	Class B		
high-frequency conducted	IEC/CISPR 22, EN 55022	Class B		

Product certifications and declarations see "Approvals and marks" on page 14.

CT-D range

Technical diagrams, Wiring notes, Dimensional drawings

Technical diagrams

Load limit curves

AC load (resistive)

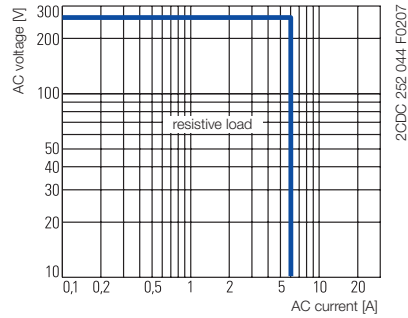

CT-D.1x

DC load (resistive)

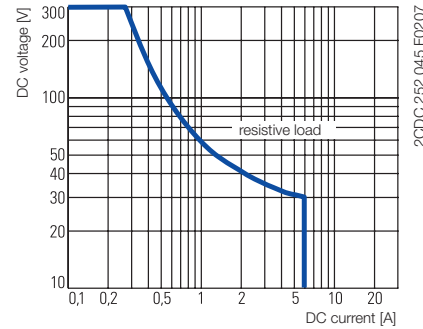

CT-D.1x

Derating factor F for inductive AC load

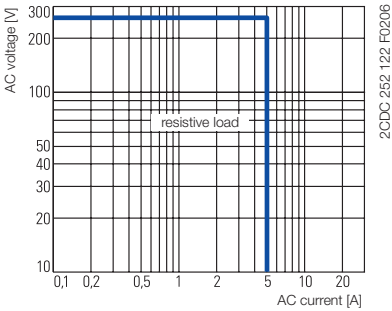
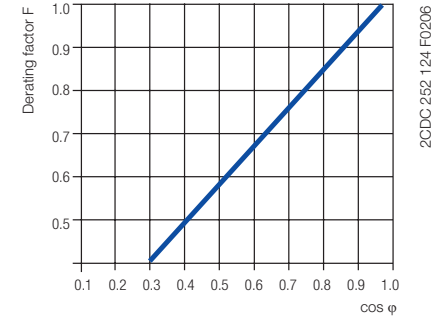

CT-D.2x

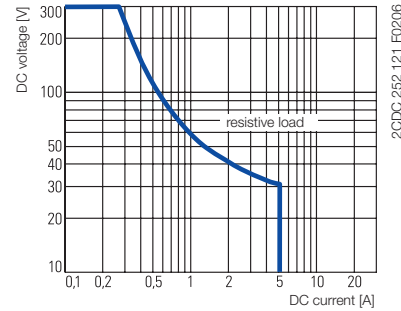

CT-D.2x

Contact lifetime

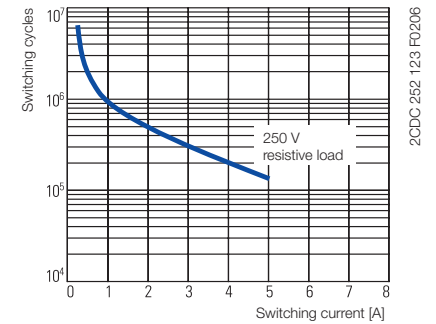

Wiring notes for devices with control input

A parallel load to the control input is possible

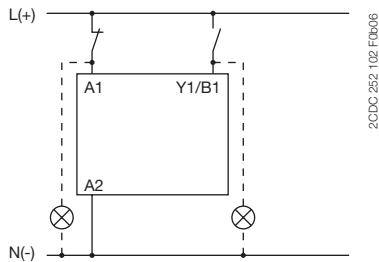

Dimensional drawings

dimensions in mm

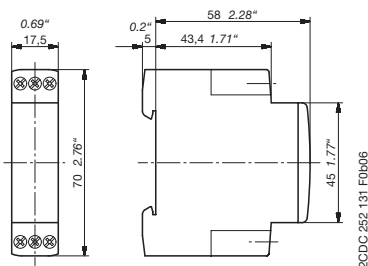

CT-D devices with 1 c/o contact or 2 n/o contacts

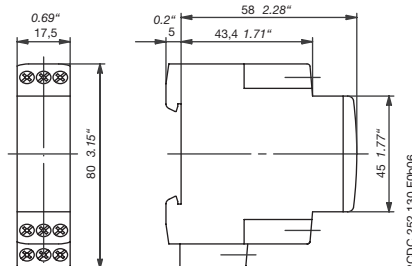

CT-D devices with 2 c/o contacts

CT-E range Product group picture

1



CT-E range

Table of contents

CT-E Range

CT-E range	24
Benefits and advantages	25
Ordering details	26
Connection diagrams	28
Connection diagrams, Technical diagrams	29
Technical data	30
Wiring notes, Dimensional drawings	32

CT-E range

Benefits and advantages

1

Characteristics

- Diversity:
 - 2 multifunction timers
 - 56 single-function timers
- Control supply voltages:
 - Dual range: 24 V AC/DC
 - Single range: 110-130 V AC, 220-240 V AC
 - Wide range: 24-240 V AC/DC (CT-MFE)
- Time ranges
 - 5 single ranges: 0.05-1 s, 0.1-10 s, 0.3-30 s, 3-300 s, 0.3-30 min
 - 8 time ranges: 0.05 s - 100 h (CT-MFE)
- Devices with 1 c/o (SPDT) contact (250 V / 4 A) or solid-state output for high switching frequencies (thyristor 0.8 A)
- Approvals / Marks (details see "Approvals and marks" on page 14)
 -

Benefits

Direct reading scales ①

Direct setting of the time delay without any additional calculation provides accurate time delay adjustment.

LEDs for status indication ②

All actual operational states are displayed by front-face LEDs, thus simplifying commissioning and troubleshooting.

Connection screws in M3 (PoziDrive 1) ③

Easy and fast tightening and release of the connection screws with pozidrive, pan- or crosshead screwdriver.

Solid-state output ④

Devices with solid-state output are the perfect solution for high operation cycles.

Synonyms

used expression	alternative expression(s)	used expression	alternative expression(s)
1 c/o contact	SPDT	voltage-related	wet / non-floating
2 c/o contacts	DPDT	volt-free	dry / floating

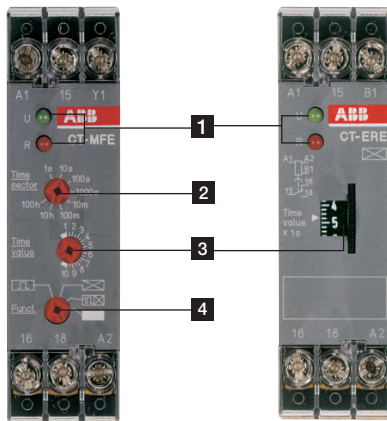

Operating controls

① LEDs for status indication

U - green LED: control supply voltage applied
 R2: red LED: output relay energized

② Time range adjustment (only multifunctional devices)

③ Fine adjustment of the time delay

④ Preselection of the timing function (only multifunctional devices)

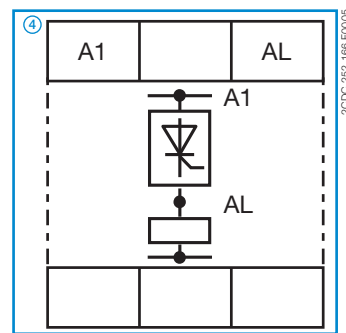
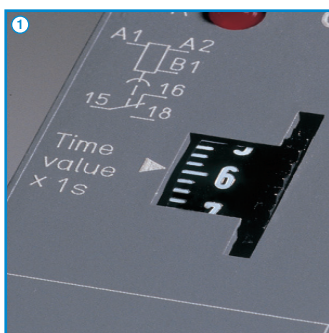

CT-E range

Ordering details



CT-MFE



CT-AHE

Description

The CT-E range with its excellent price/performance ratio offers an ideal solution for serial applications. 56 single-function devices with 5 different time ranges as well as 2 multifunction timers with 6 functions and 8 time ranges offer the highest possible flexibility for almost every application. For high operating cycles, contact-free CT-E timers with solid-state output are available.

Ordering details

Timing function	Rated control supply voltage	Time ranges	Control Input	Output	Type	Order code	Price 1 pce	Weight (1 pce) kg (lb)
Multi ¹⁾	24-240 V AC/DC	8 (0.05 s - 100 h)	■	1 c/o	CT-MFE	1SVR550029R8100		0.08 (0.18)
ON-delay	24 V AC/DC, 220-240 V AC	0.1-10 s	-	1 c/o	CT-ERE	1SVR550107R1100		0.08 (0.18)
		0.3-30 s				1SVR550107R4100		
		3-300 s				1SVR550107R2100		
	0.3-30 min	1SVR550107R5100						
	110-130 V AC	0.1-10 s	1SVR550100R1100					
		0.3-30 s	1SVR550100R4100					
3-300 s		1SVR550100R2100						
OFF-delay	24 V AC/DC	0.1-10 s	■	1 c/o	CT-AHE	1SVR550118R1100		0.08 (0.18)
		0.3-30 s				1SVR550118R4100		
		3-300 s				1SVR550118R2100		
	110-130 V AC	0.1-10 s				1SVR550110R1100		
		0.3-30 s				1SVR550110R4100		
		3-300 s				1SVR550110R2100		
OFF-delay ²⁾	24 V AC/DC, 220-240 V AC	0.1-10 s	-	1 c/o	CT-ARE	1SVR550127R1100		0.08 (0.18)
		0.3-30 s				1SVR550127R4100		
		3-300 s				1SVR550127R2100		
	110-130 V AC	0.1-10 s				1SVR550120R1100		
		0.3-30 s				1SVR550120R4100		
		3-300 s				1SVR550120R2100		
Impulse-ON	24 V AC/DC, 220-240 V AC	0.1-10 s	-	1 c/o	CT-VWE	1SVR550137R1100		0.08 (0.18)
		0.3-30 s				1SVR550137R4100		
		3-300 s				1SVR550137R2100		
	110-130 V AC	0.1-10 s				1SVR550130R1100		
		0.3-30 s				1SVR550130R4100		
		3-300 s				1SVR550130R2100		
Impulse-OFF ²⁾	24 V AC/DC	0.05-1 s	-	1 c/o	CT-AWE	1SVR550158R3100		0.08 (0.18)
	110-130 V AC					1SVR550150R3100		
	220-240 V AC					1SVR550151R3100		

1) Functions: ON-delay, OFF-delay with auxiliary voltage, Impulse-ON, Flasher starting with ON, Flasher starting with OFF, Pulse former

2) without auxiliary voltage, True Off-delay timer

■ Control input with voltage-related triggering
- no triggering



Further documentation CT-E electronic timers on www.abb.com

CT-E range

Ordering details

1



CT-MFE



CT-AHE

Description

The CT-E range with its excellent price/performance ratio offers an ideal solution for serial applications. 56 single-function devices with 5 different time ranges as well as 2 multifunction timers with 6 functions and 8 time ranges offer the highest possible flexibility for almost every application. For high operating cycles, contact-free CT-E timers with solid-state output are available.

Ordering details

Timing function	Rated control supply voltage	Time ranges	Control Input	Output	Type	Order code	Price 1 pce	Weight (1 pce) kg (lb)
Multi ¹⁾	24-240 V AC/DC	8 (0.05 s - 100 h)	■	1 c/o	CT-MFE	1SVR550029R8100		0.08 (0.18)
ON-delay	24 V AC/DC, 220-240 V AC	0.1-10 s	-	1 c/o	CT-ERE	1SVR550107R1100		0.08 (0.18)
		0.3-30 s	-			1SVR550107R4100		
		3-300 s	-			1SVR550107R2100		
	0.3-30 min	-	1SVR550107R5100					
	110-130 V AC	0.1-10 s	-		1SVR550100R1100			
		0.3-30 s	-		1SVR550100R4100			
3-300 s		-	1SVR550100R2100					
OFF-delay	24 V AC/DC	0.1-10 s	-	1 c/o	CT-AHE	1SVR550118R1100		0.08 (0.18)
		0.3-30 s	-			1SVR550118R4100		
		3-300 s	-			1SVR550118R2100		
	110-130 V AC	0.1-10 s	-		1SVR550110R1100			
		0.3-30 s	■		1SVR550110R4100			
		3-300 s	-		1SVR550110R2100			
OFF-delay ²⁾	24 V AC/DC, 220-240 V AC	0.1-10 s	-	1 c/o	CT-ARE	1SVR550127R1100		0.08 (0.18)
		0.3-30 s	-			1SVR550127R4100		
		0.1-10 s	-			1SVR550120R1100		
	110-130 V AC	0.3-30 s	-		1SVR550120R4100			
		0.1-10 s	-		1SVR550137R1100			
		0.3-30 s	-		1SVR550137R4100			
Impulse-ON	24 V AC/DC, 220-240 V AC	3-300 s	-	1 c/o	CT-VWE	1SVR550137R2100		0.08 (0.18)
		0.1-10 s	-			1SVR550130R1100		
		0.3-30 s	-			1SVR550130R4100		
	110-130 V AC	0.3-30 s	-		1SVR550130R2100			
		0.1-10 s	-		1SVR550158R3100			
		0.05-1 s	-		1SVR550150R3100			
Impulse-OFF ²⁾	24 V AC/DC			1 c/o	CT-AWE	1SVR550151R3100		0.08 (0.18)
	110-130 V AC					1SVR550150R3100		
	220-240 V AC					1SVR550151R3100		

¹⁾ Functions: ON-delay, OFF-delay with auxiliary voltage, Impulse-ON, Flasher starting with ON, Flasher starting with OFF, Pulse former

²⁾ without auxiliary voltage, True Off-delay timer

■ Control input with voltage-related triggering
- no triggering



Further documentation CT-E electronic timers on www.abb.com

CT-E range

Connection diagrams

CT-MFE

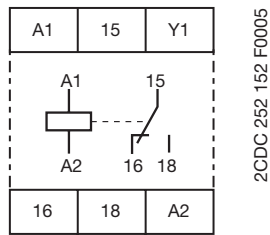

A1-A2 Supply: 24-240 V AC/DC
 A1-Y1 Control input
 15-16/18 c/o contact

CT-ERE

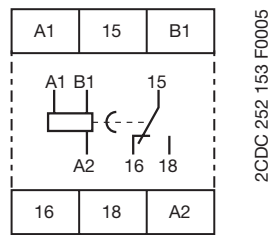

A1-A2 Supply: 220-240 V AC or 110-130 V AC
 A1-B1 Supply: 24 V AC/DC
 15-16/18 c/o contact

CT-AHE¹⁾

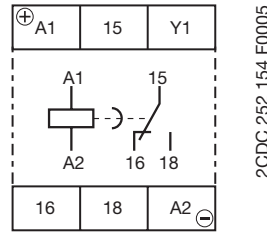

A1-A2 Supply: 24 V AC/DC or 110-240 V AC or 220-240 V AC
 A1-Y1 Control input
 15-16/18 c/o contact

CT-ARE

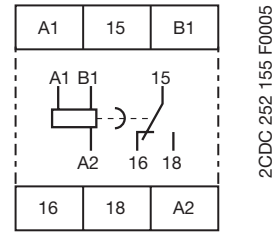

A1-A2 Supply: 220-240 V AC or 110-130 V AC
 A1-B1 Supply: 24 V AC/DC
 15-16/18 c/o contact

CT-VWE

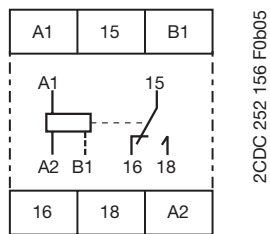

A1-A2 Supply: 220-240 V AC or 110-130 V AC
 A1-B1 Supply: 24 V AC/DC
 15-16/18 c/o contact

CT-AWE

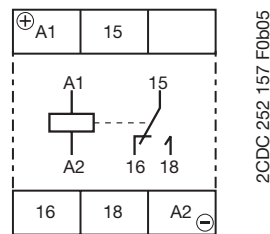

A1(+)-A2(-) Supply: 24 V AC/DC or 110-240 V AC or 220-240 V AC
 15-16/18 c/o contact

CT-AWE¹⁾

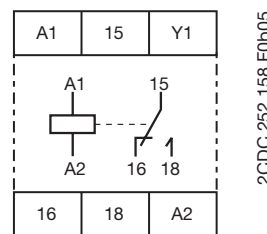

A1-A2 Supply: 24 V AC/DC or 110-240 V AC or 220-240 V AC
 A1-Y1 Control input
 15-16/18 c/o contact

CT-EBE

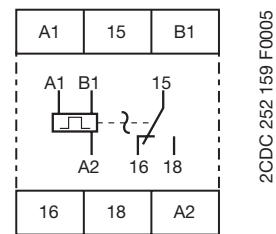

A1-A2 Supply: 220-240 V AC or 110-130 V AC
 A1-B1 Supply: 24 V AC/DC
 15-16/18 c/o contact

CT-YDE

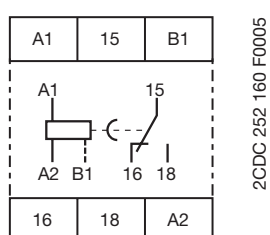

A1-A2 Supply: 220-240 V AC or 110-130 V AC
 A1-B1 Supply: 24 V AC/DC
 15-16/18 c/o contact

CT-SDE

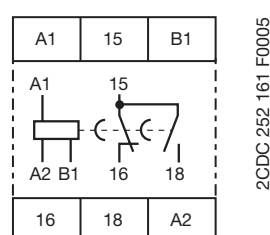

Device: 1SVR 550 217 R4100
 A1-A2 Supply: 220-240 V AC
 A1-B1 Supply: 24 V AC/DC
 15-16 n/c contact
 15-18 n/o contact with common contact

CT-SDE

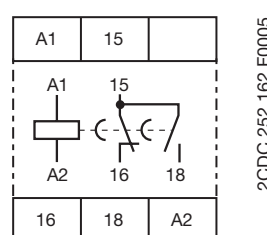

Devices: 1SVR 550 210 R4100, 1SVR 550 212 R4100
 A1-A2 Supply: 110-130 V AC or 380-415 V AC
 15-16 n/c contact
 15-18 n/o contact with common contact

CT-MKE

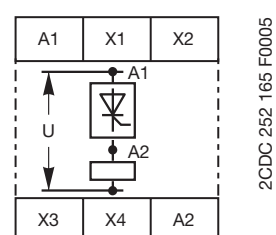

A1-A2 Supply: 24-240 V AC/DC
 A1-A2 Thyristor
 X1-X4 Timing function adjustment
 X2-X4 Timing function adjustment
 X3-X4 Time range adjustment
 (Details see function diagrams)

¹⁾ "Wiring notes, Dimensional drawings" on page 32

CT-E range

Connection diagrams, Technical diagrams

1

CT-EKE

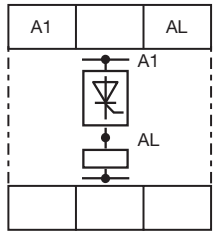

2CDC 252 166 F0005

A1-AL Supply: 24-240 V AC/DC
A1-AL Thyristor

CT-AKE

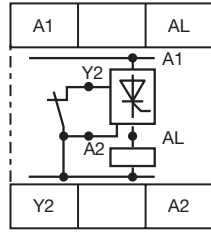

2CDC 252 167 F0005

A1-AL Supply: 24-240 V AC
A1-AL Thyristor
Y2-A2 Control input

Technical diagrams

Load limit curves AC load (resistive)

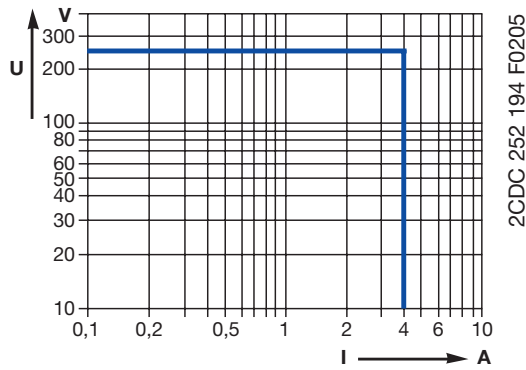

DC load (resistive)

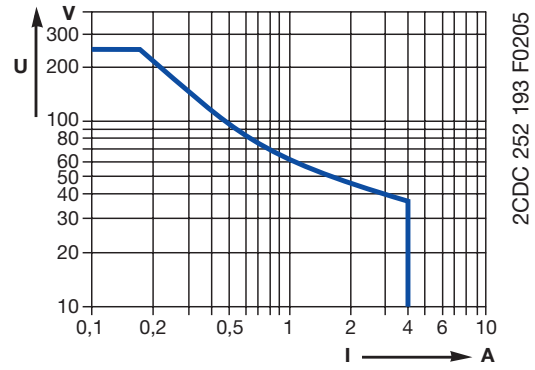

220 V 50 Hz AC1
360 cycles/h

Derating factor F for inductive AC load

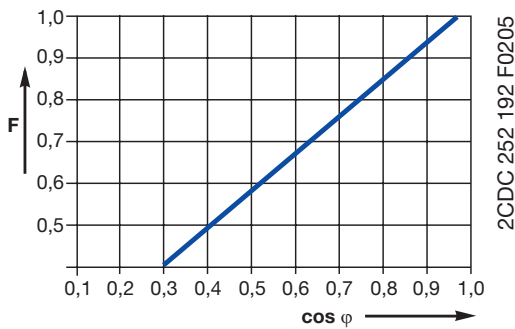

Contact lifetime

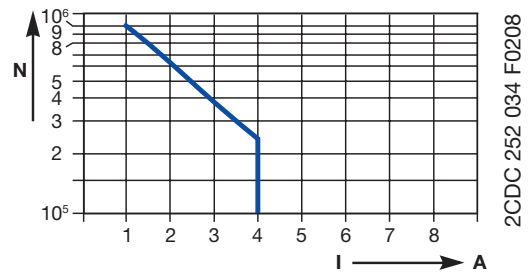

CT-E range

Technical data

Technical data

Data at $T_a = 25\text{ °C}$ and rated values, unless otherwise indicated

		CT-E (relays)	CT-E (solid-state)
Input circuit - Supply circuit			
Rated control supply voltage U_s	A1-A2, A1-AL	24-240 V AC/DC	
	A1-A2, A1-AL	24-240 V AC	
	A1-A2	110-130 V AC	-
	A1-A2	220-240 V AC	-
	A1-A2	380-415 V AC	-
	A1-B1	24 V AC/DC	-
Rated control supply voltage U_s tolerance		-15...+10 %	
Rated frequency	AC/DC versions	DC or 50/60 Hz	
	AC versions	50/60 Hz	
Typical current / power consumption	24-240 V AC/DC, 24-240 V AC	approx. 1.0-2.0 VA/W	
	110-130 V AC, 220-240 V AC	approx. 2.0 VA	-
	380-415 V AC	approx. 3.0 VA	-
	24 V AC/DC	approx. 1.0 VA/W	-
Minimum energizing time	CT-ARE, CT-AWE w/o aux. voltage	200 ms	-
Current consumption while timing		-	≤ 2 mA (24-60 V AC/DC) ≤ 8 mA (60-240 V AC/DC) (CT-AKE only AC)
Input circuit - Control circuit			
Kind of triggering		voltage-related triggering	-
Control input, Control function	A1-Y1	start timing external	-
Parallel load / polarized		no / yes ¹⁾	-
Minimum control pulse length		20 ms	-
Control voltage potential		see rated control supply voltage	-
Timing circuit			
Time ranges	1 of 5 time ranges per single-function device 8 time ranges 0.05 s - 100 h (CT-MFE)	0.05-1 s / 0.1-10 s / 0.3-30 s / 3-300 s / 0.3-30 min 1.) 0.05-1 s 2.) 0.5-10 s 3.) 5-100 s 4.) 50-1000 s 5.) 0.5-10 min 6.) 5-100 min 7.) 0.5-10 h 8.) 5-100 h	-
	2 time ranges 0.1-300 s (CT-MKE)	-	1.) 0.1-10 s 2.) 3-300 s
Recovery time		<50 ms CT-ARE: <200 ms CT-AWE, CT-SDE: <400 ms CT-YDE: <500 ms	CT-EKE: <50 ms CT-MKE: <100 ms CT-AKE: <300 ms
Accuracy within the rated control supply voltage tolerance		$\Delta t < 0.5\% / V$	
Accuracy within the temperature range		$\Delta t < 0.1\% / \text{°C}$ CT-MFE: $\Delta t < 0.06\% / \text{°C}$	-
Repeat accuracy (constant parameters)		$\Delta t < 1\%$	-
Star-delta transition time	CT-YDE / CT-SDE	50 ms / 30 ms	-
Output circuit			
Kind of output	15-16/18 CT-SDE: 15-16, 15-18	Relay, 1 c/o contact 1 n/c, 1 n/o contact with common contact	-
Contact material	A1-A2, A1-AL	-	Thyristor
Rated operational voltage U_o	IEC/EN 60947-1	AgCdO 250 V	-
Maximum switching voltage		250 V AC, 250 V DC	
Rated operational current I_o (IEC/EN 60947-5-1)	AC-12 (resistive) at 230 V AC-15 (inductive) at 230 V DC-12 (resistive) at 24 V DC-13 (inductive) at 24 V	4 A 3 A 4 A 2 A	- - - -

¹⁾ CT-MFE: yes / no

CT-E range

Technical data

1

		CT-E (relays)	CT-E (solid-state)
AC rating (UL 508)	Utilization category (Control Circuit Rating Code)	B 300	-
	max. rated operational voltage	300 V AC	-
	Maximum continuous thermal current at B300	5 A	-
	max. making/breaking apparent power at B300	3600 VA / 360 VA	-
Mechanical lifetime		30 x 10 ⁶ switching cycles	-
Electrical lifetime	at AC-12, 230 V, 4 A	0.1 x 10 ⁶ switching cycles	-
Max. fuse rating to achieve short-circuit protection (IEC/EN 60947-5-1)	n/c contact	10 A fast-acting, CT-ARE: 5 A	-
	n/o contact	10 A fast-acting, CT-ARE: 5 A	-
Minimum load current		-	CT-MKE: 20 mA CT-EKE, CT-AKE: 10 mA
Maximum load current		-	CT-MKE: 0.8 A at T _a = 20 °C CT-EKE, CT-AKE: 0.7 A
Load current reduction / Derating		-	10 mA/°C
Maximum surge current		-	CT-MKE: ≤ 20 A for t ≤ 20 ms CT-EKE, CT-AKE: ≤ 15 A
Voltage drop in connected state		-	≤ 3 V
Cable length between solid-state timer and connected load at 50 Hz and a cable capacity of 100 pF/m :	at 24 V AC	-	220 m / 22 nF
	at 42 V AC	-	100 m / 10 nF
	at 60 V AC	-	65 m / 6.5 nF
	at 110 V AC	-	50 m / 5 nF
	at 240 V AC	-	22 m / 2.2 nF
General data			
Duty time		100%	
Dimensions (W x H x D)		22.5 x 78 x 78.5 mm (0.886 x 3.07 x 3.09 in)	
Weight		approx. 80 g (0.176 lb)	
Mounting		DIN rail (IEC/EN 60715)	
Mounting position		any	
Minimum distance to other units	horizontal / vertical	no / no	
Degree of protection	housing / terminals	IP50 / IP20	
Electrical connection			
Wire size	fine-strand with wire end ferrule	2 x 0.75-1.5 mm ² (2 x 18-16 AWG)	
	fine-strand without wire end ferrule	2 x 1-1.5 mm ² (2 x 18-16 AWG)	
	rigid	2 x 0.75-1.5 mm ² (2 x 18-16 AWG)	
Stripping length		10 mm (0.39 in)	
Tightening torque		0.6-0.8 Nm (5.31-7.08 lb.in)	
Environmental data			
Ambient temperature ranges	operation / storage	-20...+60 °C / -40...+85 °C	
Damp heat	IEC/EN 60068-2-30	24 h cycle, 55 °C, 93 % rel., 96 h	
Operational reliability	IEC/EN 60068-2-6	6 g	
Mechanical resistance	IEC/EN 60068-2-6	10 g	
Isolation data			
Rated impulse withstand voltage U _{imp} between all isolated circuits	IEC/EN 60664-1	type test: 4 kV; 1.2/50 μs	-
Pollution category	IEC/EN 60664-1	3	
Overvoltage category	IEC/EN 60664-1	III	
Power-frequency withstand voltage (test voltage) between all isolated circuits		routine test: 2.5 kV; 50 Hz; 1 s type test: 2.5 kV; 50 Hz; 60 s	-
Basic insulation (IEC/EN 61140)	input circuit / output circuit	300 V	-
Rated insulation voltage U _i	input circuit / output circuit	300 V (supply up to 240 V) 500 V (supply up to 440 V)	-
Test voltage between all isolated circuits	routine test	2.5 kV, 50 Hz, 1 s	-
Standards			
Product standard		IEC 61812-1, EN 61812-1 + A11, DIN VDE 0435 Teil 2021	
Low Voltage Directive		2006/95/EC	
EMC Directive		2004/108/EC	
Electromagnetic compatibility			
Interference immunity to electrostatic discharge	IEC/EN 61000-4-2	IEC/EN 61000-6-2 Level 3 (6 kV / 8 kV)	
radiated, radio-frequency electromagnetic field	IEC/EN 61000-4-3	Level 3 (10 V/m)	
electrical fast transient / burst surge	IEC/EN 61000-4-4	Level 3 (2 kV / 5 kHz)	
conducted disturbances, induced by radio-frequency fields	IEC/EN 61000-4-5	Level 4 (2 kV L-L)	
	IEC/EN 61000-4-6	Level 3 (10 V)	
Interference emission		IEC/EN 61000-6-4	

Product certifications and declarations see "Approvals and marks" on page 14.

CT-E range

Wiring notes, Dimensional drawings

Wiring notes

for single-function devices with control contact (CT-AHE, CT-AWE with auxiliary voltage)

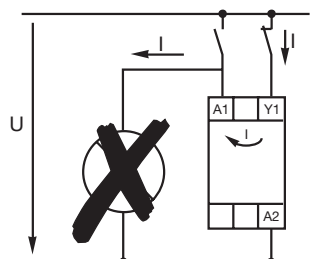

2CDC 252 200 F0b05

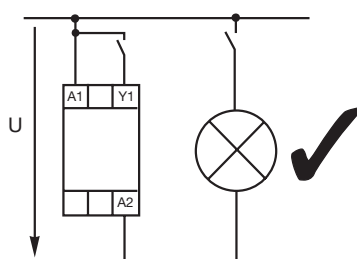

2CDC 252 199 F0b05

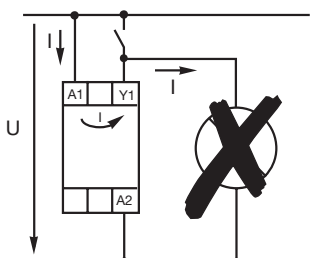

2CDC 252 198 F0b05

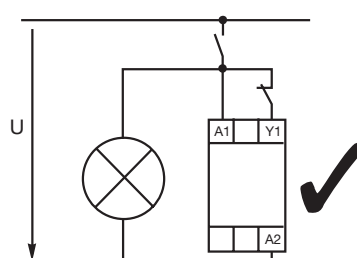

2CDC 252 201 F0b05

Dimensional drawing Dimensions in mm

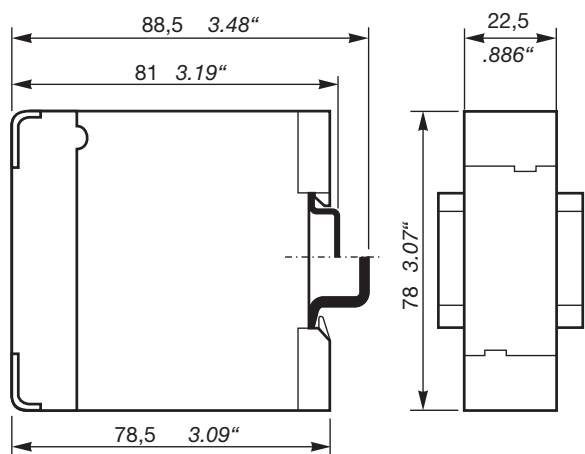

2CDC 252 189 F0b05

CT-S range

Product group picture

1



CT-S range

Table of contents

CT-S Range



CT-S range	34
Benefits and advantages	35
Ordering details - multifunctional	37
Ordering details - singlefunctional	38
Ordering details - Accessories	39
Connection diagrams	40
Technical data	42
Technical diagrams	45
Wiring notes, Dimensional drawings	46
Timing functions	47

CT-S range

Benefits and advantages

1

Characteristics

- Diversity:
 - 8 multifunction timers
 - 13 single-function timers
 - Control supply voltages:
 - Multi range: 24-48 V DC, 24-240 V AC
 - Wide range: 24-240 V AC/DC
 - Single range: 380-440 V AC
 - Innovative connection technology
 - Double-chamber cage connection terminals
 - Easy Connect Technology
 - Devices with:
 - 1 or 2 c/o (SPDT) contacts
 - 2nd c/o contact can be selected as instantaneous contact ¹⁾
 - Remote potentiometer connection ¹⁾
 - Control input with volt-free or voltage-related triggering e.g. to start timing, pause timing
 - Extended operating temperature range down to -40 °C ¹⁾
 - Sealable transparent cover for protection against unauthorized changes of time values
 - Integrated marker label
 - Approvals / Marks (partly pending, details see "Approvals and marks" on page 14)
 -  / 
- ¹⁾ selected devices

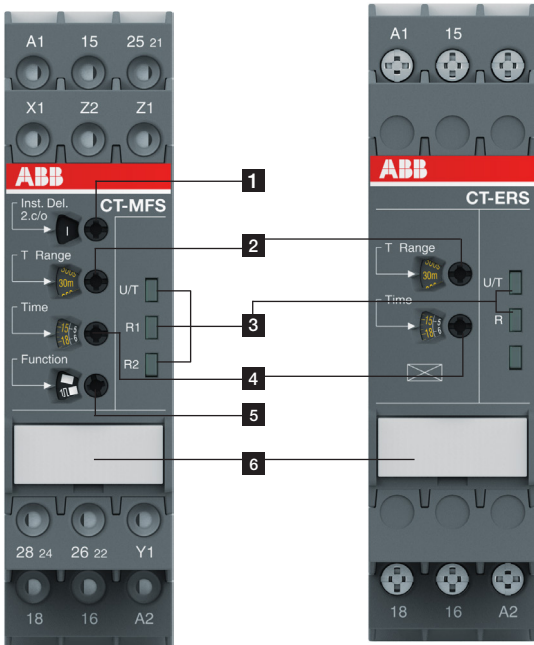

Operating controls



1 2nd contact as an instantaneous contact

2 Preselection of the time range

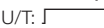
3 Indication of operational states

U/T:  control supply voltage applied /  timing
 R:  Output relay energized

4 Fine adjustment of time delay

5 Preselection of timing function

6 Marker label

CT-S range

Benefits and advantages

Easy Connect Technology ①

Tool-free wiring and excellent vibration resistance. Push-in terminals provide connection of wires up to $2 \times 0.5 - 1.5 \text{ mm}^2$ ($2 \times 20 - 16 \text{ AWG}$), rigid or fine-strand with or without wire end ferrules. The extended type designators for products with push-in terminals are indicated by a **P** following the extended type designator e.g. CT-xxS.xx**P**.

Double-chamber cage connection terminals ②

Double-chamber cage connection terminals provide connection of wires up to $2 \times 0.5-2.5 \text{ mm}^2$ ($2 \times 20-14 \text{ AWG}$) rigid or fine-strand, with or without wire end ferrules. Potential distribution does not require additional terminals. The extended type designators for products with double-chamber cage connection terminals are indicated by a **S** following the extended type designator e.g. CT-xxS.xx**S**.

Time range preselection and fine adjustment ③

Direct assignment of the preselected time range to the fine adjustment potentiometer scale by multicolor scales.

Higher utility class ④

The Easy Connect Technology provides excellent vibration resistance with gas tight push-in terminals – the right solution for harsh environment. Selected products of the electronic timers and measuring and monitoring relays comply to the latest rail standards NF F 16-101/102, EN 45545, EN 50155 and more standards which are relevant for railway applications. Find more information in the rail brochure 2CDC110084B0201.

LEDs for status indication ⑤

All actual operational states are displayed by front-face LEDs, thus simplifying commissioning and troubleshooting.

Integrated marker label ⑥

Integrated marker labels allow the product to be marked quickly and simply. No additional marker labels are required.

Sealable transparent cover ⑦

Protection against unauthorized changes of time and threshold values. Available as an accessory.

Snap-On housing ⑧

Tool-free DIN rail installation and deinstallation of the electronic timer.

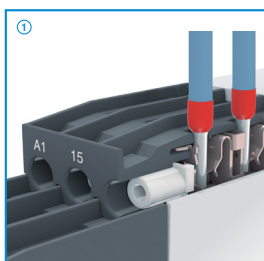

2CDC 253 025 F0011

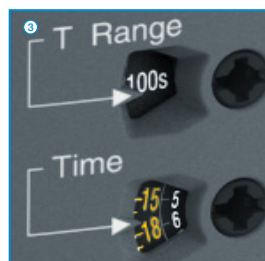

2CDC 253 035 F0011

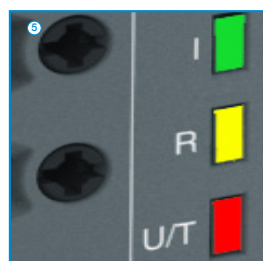

2CDC 252 006 F0012

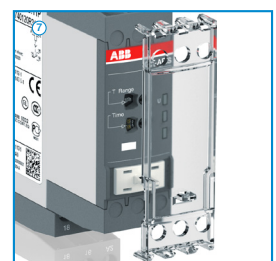

2CDC 255 006 S0011

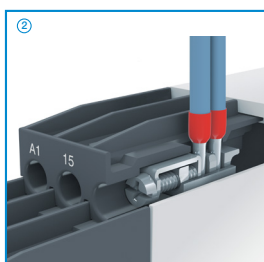

2CDC 253 025 F0011



2CDC 110 084 B0201

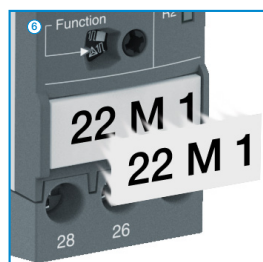

2CDC 253 007 F0012

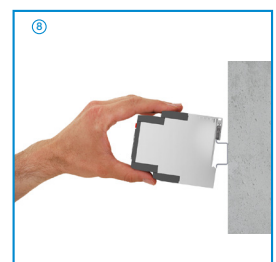

2CDC 253 013 F0013

CT-S range

Ordering details - multifunctional

1



CT-MVS.21P



CT-MBS.22P

Description

The high-performance CT-S range in ABB's new S-range housing offers two different types of connection terminals and is ideally suited for universal use. Two different connection technologies are available:

- Double-chamber cage connection terminals
- Easy Connect Technology

Accessories:

The CT-S range offers the possibility of using accessories such as a remote potentiometer to adjust the time delay or a sealable, transparent cover to protect against unauthorized changes of time and threshold values.

Ordering details

Timing function	Rated control supply voltage	Time ranges	Control input	Output	Type	Order code	Price	Weight
							1 pce	(1 pce)
Multi ⁵⁾	24- 240 V AC/DC	10 (0.05 s - 300 h)	■	2 c/o	CT-MVS.21S ^{1) 2) 3)}	1SVR730020R0200	0.148	0.148
					CT-MVS.21P ^{1) 2) 3)}	1SVR740020R0200	(0.326)	0.136
	CT-MVS.22S				1SVR730020R3300	(0.313)	0.142	
	CT-MVS.22P				1SVR740020R3300	(0.289)	0.131	
	CT-MVS.23S				1SVR730021R2300	(0.317)	0.144	
Multi ⁶⁾	24-48 V DC, 24-240 V AC	380-440 V AC	■	1 c/o	CT-MVS.23P	1SVR740021R2300	(0.293)	0.133
					CT-MVS.12S	1SVR730020R3100	(0.236)	0.107
Multi ⁷⁾	24-48 V DC, 24-240 V AC	2x10 (0.05 s - 300 h)	■	2 c/o	CT-MVS.12P	1SVR740020R3100	(0.225)	0.102
					CT-MXS.22S ⁴⁾	1SVR730030R3300	(0.313)	0.142
Multi ⁸⁾	24- 240 V AC/DC	10 (0.05 s - 300 h)	□ / □	2 c/o	CT-MXS.22P ⁴⁾	1SVR740030R3300	(0.289)	0.131
					CT-MFS.21S ^{1) 2) 3)}	1SVR730010R0200	(0.32)	0.145
	CT-MFS.21P ^{1) 2) 3)}				1SVR740010R0200	(0.293)	0.133	
Multi ⁹⁾	24-48 V DC, 24-240 V AC	10 (0.05 s - 300 h)	□ / □	2 c/o	CT-MBS.22S ^{2) 3)}	1SVR730010R3200	(0.309)	0.14
					CT-MBS.22P ^{2) 3)}	1SVR740010R3200	(0.284)	0.129
Multi ⁹⁾	24-48 V DC, 24-240 V AC	10 (0.05 s - 300 h)	-	2 c/o	CT-WBS.22S	1SVR730040R3300	(0.271)	0.123
					CT-WBS.22P	1SVR740040R3300	(0.254)	0.115

- Control input with voltage-related triggering
- Control input with volt-free triggering
- / □ two control input with volt-free triggering
- no triggering
- S: screw connection
- P: push-in / easy connect

¹⁾ Extended temperature range -40 °C

²⁾ Remote potentiometer connection

³⁾ 2nd c/o contact selectable as instantaneous contact

⁴⁾ 2 remote potentiometer connections

⁵⁾ Functions: ON-delay, OFF-delay with auxiliary voltage, Impulse-ON, Impulse-OFF with auxiliary voltage, Symmetrical ON- and OFF-delay, Flasher starting with ON or OFF, Star-delta change-over with impulse, Pulse former, Accumulative ON-delay, ON/OFF-function

⁶⁾ Functions: ON-delay, OFF-delay with auxiliary voltage, Impulse-ON, Impulse-OFF with auxiliary voltage, Symmetrical ON- and OFF-delay, Flasher starting with ON or OFF, Pulse former, Accumulative ON-delay, ON/OFF-function

⁷⁾ Functions: Select function via DIP switches behind the marker label on the front of the unit, asymmetrical ON- and OFF-delay, Impulse-ON/OFF, Pulse generator starting with ON or OFF, Single pulse generator, ON/OFF-function

⁸⁾ Functions: ON-delay, OFF-delay with auxiliary voltage, Impulse-ON, Impulse-OFF with auxiliary voltage, Symmetrical ON- and OFF-delay, Flasher starting with ON, Flasher starting with OFF, Star-delta change-over with impulse, Pulse former, ON/OFF-function

⁹⁾ Functions: Flasher starting with ON, Flasher starting with OFF, Impulse-ON, ON-delay, fixed impulse with adjustable time delay, Adjustable impulse with fixed time delay, ON/OFF-function



Further documentation CT-S electronic timers on www.abb.com

CT-S range

Ordering details - singlefunctional



2CDC 251 030 V0011

CT-ERS.21P



2CDC 251 033 V0011

CT-AHS.22P



2CDC 251 040 V0011

CT-SDS.23P

Timing function	Rated control supply voltage	Time ranges	Control input	Output	Type	Order code	Price	Weight						
							1 pce	(1 pce) kg (lb)						
ON-delay	24-240 V AC/DC	10 (0.05 s - 300 h)	-	2 c/o	CT-ERS.21S ¹⁾	1SVR730100R0300		0.13 (0.287)						
					CT-ERS.21P ¹⁾	1SVR740100R0300		0.121 (0.267)						
	CT-ERS.22S				1SVR730100R3300		0.121 (0.267)							
	CT-ERS.22P				1SVR740100R3300		0.113 (0.249)							
	CT-ERS.12S				1SVR730100R3100		0.106 (0.234)							
	CT-ERS.12P				1SVR740100R3100		0.101 (0.222)							
OFF-delay	24-240 V AC/DC	10 (0.05 s - 300 h)	■	2 c/o	CT-APS.21S ¹⁾	1SVR730180R0300		0.146 (0.322)						
					CT-APS.21P ¹⁾	1SVR740180R0300		0.125 (0.276)						
	CT-APS.22S				1SVR730180R3300		0.138 (0.304)							
	CT-APS.22P				1SVR740180R3300		0.127 (0.28)							
	CT-APS.12S				1SVR730180R3100		0.109 (0.24)							
	CT-APS.12P				1SVR740180R3100		0.103 (0.227)							
OFF-delay ⁵⁾	24-48 V DC, 24-240 V AC	10 (0.05 s - 300 h)	■	2 c/o	CT-AHS.22S	1SVR730110R3300		0.136 (0.30)						
					CT-AHS.22P	1SVR740110R3300		0.125 (0.276)						
	24-240 V AC/DC				7 (0.05 s - 10 min)	-	1 c/o	CT-ARS.11S	1SVR730120R3100		0.106 (0.234)			
								CT-ARS.11P	1SVR740120R3100		0.10 (0.22)			
	24-48 V DC, 24-240 V AC							7 (0.05 s - 10 min)	-	2 c/o	CT-ARS.21S	1SVR730120R3300		0.124 (0.273)
											CT-ARS.21P	1SVR740120R3300		0.115 (0.254)
380-440 V AC	7 (0.05 s - 10 min)	-	2 n/o	CT-SDS.22S							1SVR730210R3300		0.114 (0.251)	
				CT-SDS.22P							1SVR740210R3300		0.108 (0.238)	
				CT-SDS.23S	1SVR730211R2300		0.118 (0.26)							
CT-SDS.23P				1SVR740211R2300		0.112 (0.247)								

¹⁾ Extended temperature range -40 °C
²⁾ Remote potentiometer connection
³⁾ 2nd c/o contact selectable as instantaneous contact
⁴⁾ 2 remote potentiometer connections
⁵⁾ Without auxiliary voltage
⁶⁾ 50 ms transition time

■ Control input with voltage-related triggering
□ Control input with volt-free triggering
□ / □ two control input with volt-free triggering
- no triggering
S: screw connection
P: push-in / easy connect



Further documentation CT-S electronic timers on www.abb.com

CT-S range

Ordering details - Accessories

1



MT-x50B

1SFC 151 138 V0001

Remote potentiometer

50 k Ω \pm 20 % - 0.2 Ω , degree of protection IP66

Material	Diameter in mm	Type	Order code	Price 1 piece	Pack.- unit pieces	Weight 1 piece g / oz
Plastic, black	22.5	MT-150B	1SFA611410R1506		1	0.040
Plastic, chrome	22.5	MT-250B	1SFA611410R2506		1	0.040
Metal, chrome	22.5	MT-350B	1SFA611410R3506		1	0.048



Data sheet remote potentiometer



30 mm adapters

2CDC 252 042 F0009

30 mm adapter for attaching the potentiometer 22 mm in 30 mm mounting hole

Material	Type	Order code	Price 1 piece	Pack.- unit pieces	Weight 1 piece g / oz
Plastic, black	KA1-8029	1SFA616920R8029		1	
Metal, chrome	KA1-8030	1SFA616920R8030		1	

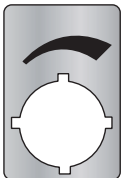

Marker label 29.6 x 44.5 mm

2CDC 252 043 F0209

Marker label

Caption	Type	Order code	Price 1 piece	Pack.- unit pieces	Weight 1 piece g / oz
Symbol (see illustration)	SK 615 562-87	GJD6155620R0087		1	0.002
Scale 0 - 10	SK 615 562-88	GJD6155620R0088		1	0.002
Scale 0 - 30	MA16-1060	1SFA611940R1060		1	0.002

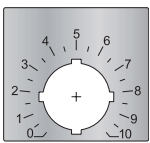

Marker label with scale 0-10
48.5 x 44.5 mm

2CDC 252 044 F0209

Accessories for CT-S in new housing (1SVR7...)

Description	Type	Order code	Price 1 piece	Pack.- unit pieces	Weight 1 piece g / oz
Adapter for screw mounting	ADP.01	1SVR430029R0100		1	0.018 (0.040)
Sealable transparent cover	COV.11	1SVR730005R0100		1	0.004 (0.009)
Marker label for devices w/o DIP switches	MAR.01	1SVR366017R0100		10	0.001 (0.002)
Marker label for devices with DIP switches	MAR.12	1SVR730006R0000		10	0.001 (0.002)

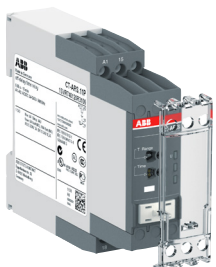

Sealable transparent cover for
CT-S in new housing

2CDC 255 006 S0011

Accessories for CT-S in old housing (1SVR4...)

Description	Type	Order code	Price 1 piece	Pack.- unit pieces	Weight 1 piece g / oz
Adapter for screw mounting	ADP.01	1SVR430029R0100		1	0.018 (0.040)
Sealable transparent cover	COV.01	1SVR430005R0100		1	0.004 (0.009)
Marker label for devices w/o DIP switches	MAR.01	1SVR366017R0100		10	0.001 (0.002)
Marker label for devices with DIP switches	MAR.02	1SVR430043R0000		10	0.001 (0.002)

CT-S range

Connection diagrams

CT-MVS.21

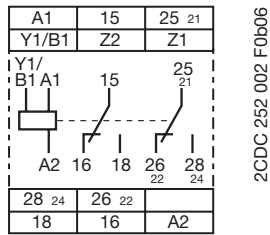

2CDC 252 002 F0b06

A1-A2 Supply: 24-240 V AC/DC
 A1-Y1/B1 Control input
 15-16/18 1. c/o contact
 25-26/28 2. c/o contact
 21-22/24 2. c/o contact as instantaneous contact
 Z1-Z2 Remote potentiometer connection

CT-MVS.22

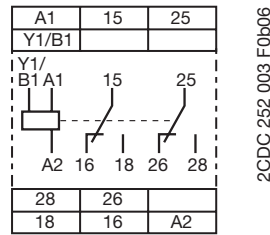

2CDC 252 003 F0b06

A1-A2 Supply: 224-48 V DC or 24-240 V AC
 A1-Y1/B1 Control input
 15-16/18 1. c/o contact
 25-26/28 2. c/o contact

CT-MVS.23

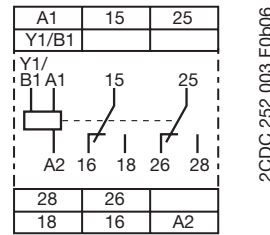

2CDC 252 003 F0b06

A1-A2 Supply: 380-440V AC
 A1-Y1/B1 Control input
 15-16/18 1. c/o contact
 25-26/28 2. c/o contact

CT-MVS.12

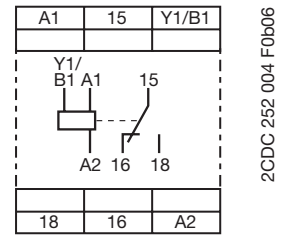

2CDC 252 004 F0b06

A1-A2 Supply: 24-48 V DC or 24-240 V AC
 A1-Y1/B1 Control input
 15-16/18 1. c/o contact

CT-MXS.22

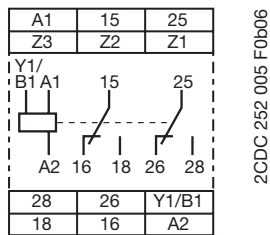

2CDC 252 005 F0b06

A1-A2 Supply: 24-48 V DC or 24-240 V AC
 A1-Y1/B1 Control input
 15-16/18 1. c/o contact
 25-26/28 2. c/o contact
 Z1-Z2 Remote potentiometer connection
 Z3-Z2 Remote potentiometer connection

CT-MFS.21

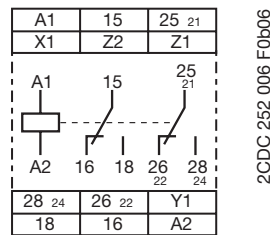

2CDC 252 006 F0b06

A1-A2 Supply: 24-240 V AC/DC
 15-16/18 1. c/o contact
 25-26/28 2. c/o contact
 21-22/24 2. c/o contact as instantaneous contact
 Y1-Z2 Control input
 X1-Z2 Control input
 Z1-Z2 Remote potentiometer connection

CT-MBS.22

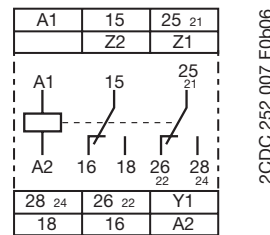

2CDC 252 007 F0b06

A1-A2 Supply: 24-48 V DC or 24-240 V AC
 15-16/18 1. c/o contact
 25-26/28 2. c/o contact
 21-22/24 2. c/o contact as instantaneous contact
 Y1-Z2 Control input
 Z1-Z2 Remote potentiometer connection

CT-WBS.22

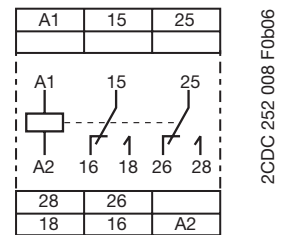

2CDC 252 008 F0b06

A1-A2 Supply: 24-48 V DC or 24-240 V AC
 15-16/18 1. c/o contact
 25-26/28 2. c/o contact

CT-ERS.21

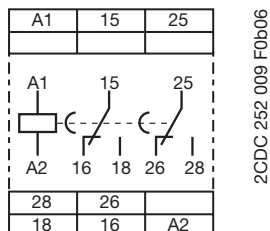

2CDC 252 009 F0b06

A1-A2 Supply: 24-240 V AC/DC
 15-16/18 1. c/o contact
 25-26/28 2. c/o contact

CT-ERS.22

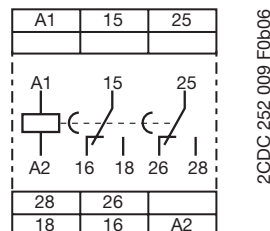

2CDC 252 009 F0b06

A1-A2 Supply: 24-48 V DC or 24-240 V AC
 15-16/18 1. c/o contact
 25-26/28 2. c/o contact

CT-ERS.12

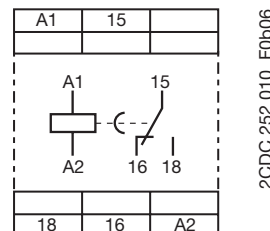

2CDC 252 010 F0b06

A1-A2 Supply: 24-48 V DC or 24-240 V AC
 15-16/18 1. c/o contact

CT-S range

Connection diagrams

1

CT-APS.21

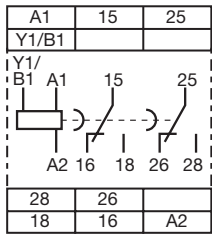

2CDC 252 011 F0b06

A1-A2 Supply: 24-240 V AC/DC
 A1-Y1/B1 Control input
 15-16/18 1. c/o contact
 25-26/28 2. c/o contact

CT-APS.22

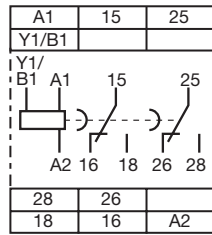

2CDC 252 011 F0b06

A1-A2 Supply: 24-48 V DC or 24-240 V AC
 A1-Y1/B1 Control input
 15-16/18 1. c/o contact
 25-26/28 2. c/o contact

CT-APS.12

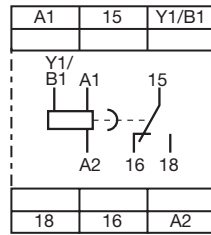

2CDC 252 012 F0b06

A1-A2 Supply: 24-48 V DC or 24-240 V AC
 A1-Y1/B1 Control input
 15-16/18 1. c/o contact

CT-AHS.22

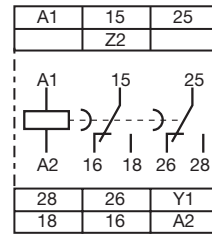

2CDC 252 013 F0b06

A1-A2 Supply: 24-48 V DC or 24-240 V AC
 Y1-Z2 Control input
 15-16/18 1. c/o contact
 25-26/28 2. c/o contact

CT-ARS.11

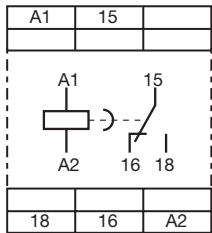

2CDC 252 014 F0b06

A1-A2 Supply: 24-240 V AC/DC
 15-16/18 1. c/o contact

CT-ARS.21

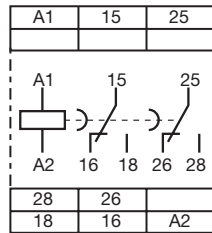

2CDC 252 015 F0b06

A1-A2 Supply: 24-240 V AC/DC
 15-16/18 1. c/o contact
 25-26/28 2. c/o contact

△ CT-SDS.22

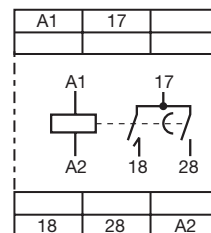

2CDC 252 016 F0b06

A1-A2 Supply: 24-48 V DC or 24-240 V AC
 17-18 1. n/o contact
 17-28 2. n/o contact

△ CT-SDS.23

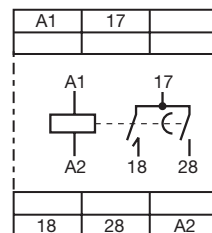

2CDC 252 016 F0b06

A1-A2 Supply: 380-440 V AC
 17-18 1. n/o contact
 17-28 2. n/o contact

CT-S range

Technical data

Data at $T_a = 25\text{ °C}$ and rated values, unless otherwise indicated

		CT-S
Input circuit - Supply circuit		
Rated control supply voltage U_s	CT-xxx.x1	24-240 V AC/DC
	CT-xxx.x2	24-48 V DC, 24-240 V AC
	CT-xxx.x3	380-440 V AC
	CT-xxx.x4	110-240 V AC
	CT-xxx.x5	220-240 V AC
	CT-xxx.x6	24 V AC/DC
	CT-xxx.x7	100-127 V AC or 110 V DC
	CT-xxx.x8	200-240V AC/DC
Rated control supply voltage U_s tolerance		-15...+10 %
Rated frequency		DC or 50/60 Hz
Frequency range AC		47-63 Hz
Typical current / power consumption		depending on device, see data sheet
Power failure buffering time	24 V DC	min. 15 ms
	230/400 V AC	min. 20 ms
Minimum energizing time		100 ms (CT-ARS)
Formatting time ¹⁾		5 min (CT-ARS)
Input circuit - Control circuit		
Kind of triggering	CT-MVS, CT-MXS, CT-APS	voltage-related triggering
Control input, Control function	A1-Y1/B1	start timing external
Parallel load / polarized		yes / no
Maximum cable length to the control input		50 m - 100 pF/m
Minimum control pulse length		20 ms
Control voltage potential		see rated control supply voltage
Current consumption of the control input	24 V DC	1.2 mA
	230 V AC	8 mA
	400 V AC	6 mA
Kind of triggering	CT-MFS, CT-MBS, CT-AHS	volt-free triggering
Control input, Control function	Y1-Z2	start timing external
	X1-Z2	pause timing / accumulative functions (CT-MFS)
Maximum switching current in the control circuit		1 mA
Maximum cable length to the control input		50 m - 100 pF/m
Minimum control pulse length		20 ms
No-load voltage at the control inputs		10-40 V DC
Remote potentiometer		
Remote potentiometer connections, Resistance value	Z1-Z2	50 k Ω (CT-MFS, CT-MBS, CT-MVS.21, CT-MXS)
	Z3-Z2	50 k Ω (CT-MXS)
Maximum cable length to remote potentiometer		2 x 25 m, shielded with 100 pF/m
Shield connection		Z2
Timing circuit		
Time ranges	10 time ranges 0.05 s - 300 h	1.) 0.05-1 s 2.) 0.15-3 s 3.) 0.5-10 s 4.) 1.5-30 s 5.) 5-100 s 6.) 15-300 s 7.) 1.5-30 min 8.) 15-300 min 9.) 1.5-30 h 10.) 15-300 h
	7 time ranges 0.05 s - 10 min (CT-SDS, CT-ARS)	1.) 0.05-1 s 2.) 0.15-3 s 3.) 0.5-10 s 4.) 1.5-30 s 5.) 5-100 s 6.) 15-300 s 7.) 0.5-10 min
Recovery time	24-240 V AC/DC	< 50 ms
	24-48 V DC, 24-240 V AC	< 80 ms
	380-440 V AC	< 60 ms
Accuracy within the rated control supply voltage tolerance		$\Delta t < 0.004\%$ / V
Accuracy within the temperature range		$\Delta t < 0.03\%$ / °C
Repeat accuracy (constant parameters)		< $\pm 0.2\%$
Star-delta transition time ¹⁾ prior to first commissioning and after a six-month stop in operation		fixed 50 ms (CT-SDS, CT-MBS, CT-MFS, CT-MVS.2x)
Star-delta transition time tolerance		± 2 ms

CT-S range

Technical data

1

Indication of operational states		
Control supply voltage / timing	U/T: green LED	: control supply voltage applied / : timing
Control supply voltage	U: green LED	: control supply voltage applied
Relay state	R, R1, R2: yellow LED	: output relay energized
Output circuit		
Kind of output	15-16/18	relay, 1 c/o contact
	15-16/18; 25-26/28	relay, 2 c/o contacts
	15-16/18; 25(21)-26(22)/28(24)	relay, 2 c/o contacts, 2nd c/o contact selectable as inst. contact
	17-18; 17-28	relay, 2 n/o contacts (CT-SDS)
Contact material		Cd-free, on request
Rated operational voltage U _e	IEC/EN 60947-1	250 V
Minimum switching voltage / minimum switching current		12 V / 10 mA
Maximum switching voltage / maximum switching current		see load limit curves
Rated operational current I _e (IEC/EN 60947-5-1)	AC-12 (resistive) at 230 V	4 A
	AC-15 (inductive) at 230 V	3 A
	DC-12 (resistive) at 24 V	4 A
	DC-13 (inductive) at 24 V	2 A (CT-ARS; 1.5 A)
AC rating (UL 508)	Utilization category (Control Circuit Rating Code)	B 300
	max. rated operational voltage	300 V AC
	Maximum continuous thermal current at B300	5 A
	max. making/breaking apparent power at B300	3600 VA / 360 VA
Mechanical lifetime		30 x 10 ⁶ switching cycles
Electrical lifetime	at AC-12, 230 V, 4 A	0.1 x 10 ⁶ switching cycles
Max. fuse rating to achieve short-circuit protection (IEC/EN 60947-5-1)	n/c contact	6 A fast-acting
	n/o contact	10 A fast-acting
General data ²⁾		
MTBF		on request
Duty time		100%
Dimensions (W x H x D)	product dimensions	22.5 x 85.6 x 103.7 mm (0.89 x 3.37 x 4.08 in)
	packaging dimensions	97 x 109 x 30 mm (3.82 x 4.29 x 1.18 in)
Weight		depending on device, see ordering details
Mounting		DIN rail (IEC/EN 60715), snap-on mounting without any tool
Mounting position		any
Minimum distance to other units	vertical / horizontal	not necessary / not necessary
Material of housing		UL 94 V-0
Degree of protection	housing / terminals	IP50 / IP20
Electrical connection ²⁾		
Wire size	fine-strand with(out) wire end ferrule	Screw connection technology
		Easy Connect Technology (Push-in)
		1 x 0.5-2.5 mm ² (1 x 20-14 AWG) 2 x 0.5-1.5 mm ² (2 x 20-16 AWG)
	rigid	1 x 0.5-4 mm ² (1 x 20-12 AWG) 2 x 0.5-2.5 mm ² (2 x 20-14 AWG)
Stripping length		8 mm (0.32 in)
Tightening torque		0.6-0.8 Nm (5.31-7.08 lb.in)

²⁾ Data for all references 1SVR 730 xxx xxx and 1SVR 740 xxx xxx. For devices with 1SVR 430 xxx xxx please refer to the data sheet.

CT-S range

Technical data

1

Environmental data

Ambient temperature ranges	operation / storage	-25...+60 °C / -40...+85 °C, -40...+60 °C / -40...+85 °C (CT-MVS.21, CT-MFS.21, CT-ERS.21, CT-APS.21)
Damp heat (cyclic) (IEC/EN 60068-2-30)		6 x 24 h cycle, 55 °C, 95 % RH
Vibration, sinusoidal (IEC/EN 60068-2-6)	functioning resistance	40 m/s ² , 10-58/60-150 Hz 60 m/s ² , 10-58/60-150 Hz, 20 cycles
Vibration, seismic (IEC/EN 60068-3-3)	functioning	20 m/s ²
Shock, half-sine (IEC/EN 60068-2-27)	functioning resistance	100 m/s ² , 11 ms, 3 shocks/direction 300 m/s ² , 11 ms, 3 shocks/direction

Isolation data

		CT-S with 1 c/o	CT-S with 2 c/o
Rated insulation voltage U _i	input circuit / output circuit	500 V	
	output circuit 1 / output circuit 2	not available	300 V
Rated impulse withstand voltage U _{imp} between all isolated circuits (IEC/EN 60664-1)		type test: 4 kV; 1.2/50 μs	
Power-frequency withstand voltage (test voltage) between all isolated circuits		routine test: 2.0 kV; 50 Hz; 1 s type test: 2.0 kV; 50 Hz; 60 s	
Basic insulation (IEC/EN 61140)	input circuit / output circuit	500 V	
Protective separation (IEC/EN 61140; EN 50178)	input circuit / output circuit	250 V	
Pollution degree	IEC/EN 60664-1	3	
Overvoltage category	IEC/EN 60664-1	III	

Standards

Product standard	IEC 61812-1, EN 61812-1 + A11, DIN VDE 0435 part 2021
Low Voltage Directive	2006/95/EC
EMC Directive	2004/108/EC
RoHS Directive	2011/65/EC

Electromagnetic compatibility

Interference immunity to		IEC/EN 61000-6-1, IEC/EN 61000-6-2
electrostatic discharge	IEC/EN 61000-4-2	Level 3, 6 kV / 8 kV
radiated, radio-frequency electromagnetic field	IEC/EN 61000-4-3	Level 3, 10 V/m (1 GHz) 3 V/m (2 GHz) 1 V/m (2.7 GHz)
electrical fast transient / burst	IEC/EN 61000-4-4	Level 3, 2 kV / 5 kHz
surge	IEC/EN 61000-4-5	Level 4, 2 kV A1-A2
conducted disturbances, induced by radio-frequency fields	IEC/EN 61000-4-6	Level 3, 10 V
harmonics and interharmonics	IEC/EN 61000-4-13	Class 3
Interference emission		IEC/EN 61000-6-3, IEC/EN 61000-6-4
high-frequency radiated	IEC/CISPR 22, EN 55022	Class B
high-frequency conducted	IEC/CISPR 22, EN 55022	Class B

Product certifications and declarations see "Approvals and marks" on page 14.

CT-S range

Technical diagrams

1

Technical diagrams

Load limit curves

AC load (resistive)

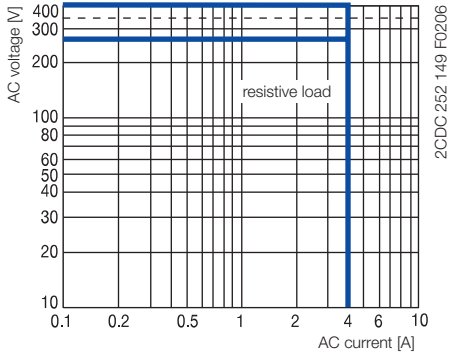

DC load (resistive)

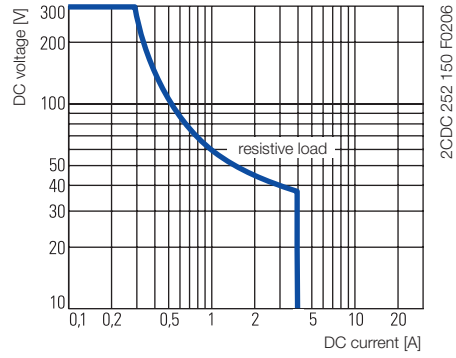

Derating factor F for inductive AC load

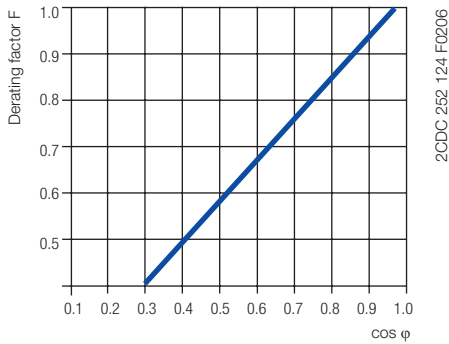

Contact lifetime

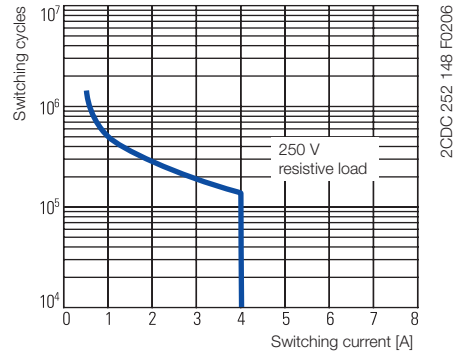

CT-S range

Wiring notes, Dimensional drawings

Wiring notes

Control inputs (volt-free triggering)

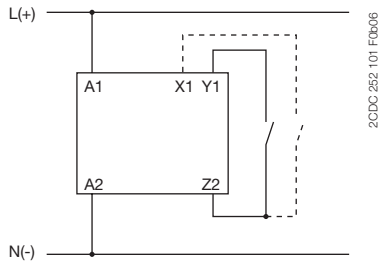

Triggering of the control inputs (volt-free) with a proximity switch (3 wire)

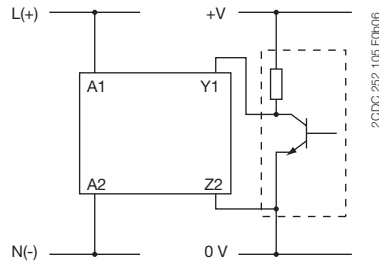

Control inputs (voltage-related triggering)

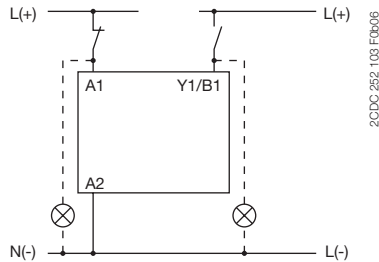
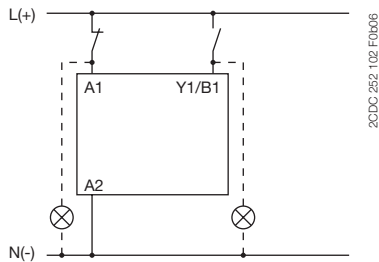

The control input Y1/B1 is triggered with electric potential against A2. It is possible to use the control supply voltage from terminal A1 or any other voltage within the rated control supply voltage range.

Remote potentiometer

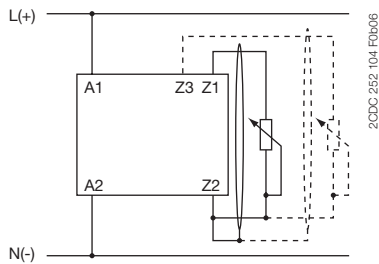

Dimensional drawing Dimensions in mm

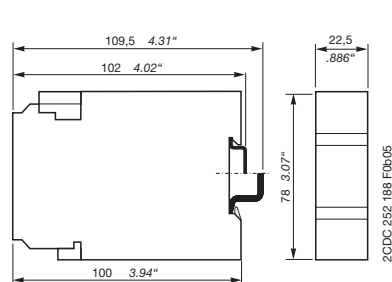

1SVR 430 xxx xxx

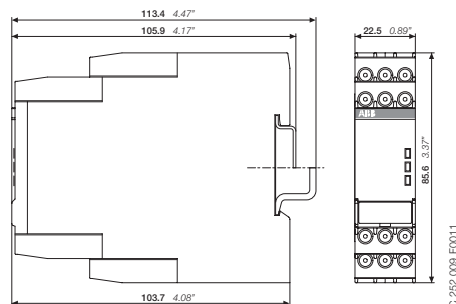

1SVR 730 xxx xxx, 1SVR 740 xxx xxx

Electronic timers

Timing functions

1

For a detailed overview of product specific timing functions please refer to the corresponding data sheet.

On delay functions

ON-delay



This function requires continuous control supply voltage for timing. Timing begins when control supply voltage is applied. When the selected time delay is complete, the output relay energizes. If control supply voltage is interrupted, the output relay de-energizes and the time delay is reset.

ON-delay accumulative



This function requires continuous control supply voltage for timing. Timing begins when control supply voltage is applied. When the selected time delay is complete, the output relay energizes. Timing can be paused by closing control input. The elapsed time t_1 is stored and continues from this time value when the control input is re-opened. If control supply voltage is interrupted, the output relay de-energizes and the time delay is reset.

OFF delay functions

OFF-delay with auxiliary voltage

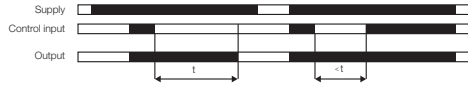

This function requires continuous control supply voltage for timing. If control input is closed, the output relay energizes immediately. If control input is opened, the time delay starts. When the selected time delay is complete, the output relay de-energizes. If control input recloses before the time delay is complete, the time delay is reset and the output relay does not change state. Timing starts again when control input A1-Y1/B1 re-opens. If control supply voltage is interrupted, the output relay de-energizes and the time delay is reset.

OFF-delay without auxiliary voltage



The OFF-delay function without auxiliary voltage does not require continuous control supply voltage for timing. Applying control supply voltage, energizes the output relay. If control supply voltage is interrupted, the OFF-delay starts. When timing is complete, the output relay de-energizes. If control supply voltage is re-applied before the time delay is complete, the time delay is reset and the output relay remains energized. Control supply voltage must be applied for the minimum energizing time (200 ms), for proper operation.

OFF-delay with auxiliary voltage (Delay on break)

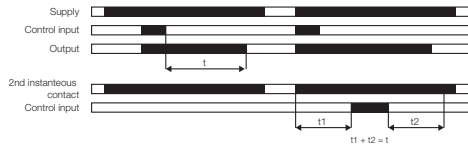

This function requires continuous control supply voltage for timing. If control input is closed, the output relay energizes immediately. If control input is opened, the time delay starts. When the selected time delay is complete, the output relay de-energizes. If control input closes before the time delay is complete, the time delay is reset and the output relay does not change state. Timing starts again when control input reopens. Pause timing / Accumulative OFF-delay: Timing can be paused by closing control input X1-Z2. The elapsed time t_1 is stored and continues from this time value when X1-Z2 is re-opened. This can be repeated as often as required. If control supply voltage is interrupted, the output relay de-energizes and the time delay is reset.

Impulse-ON functions

Impulse-ON (interval)



This function requires continuous control supply voltage for timing. The output relay energizes immediately when control supply voltage is applied and de-energizes after the set pulse time is complete. If control supply voltage is interrupted, the output relay de-energizes and the time delay is reset.

Electronic timers

Timing functions

Impulse-OFF functions

Impulse-OFF

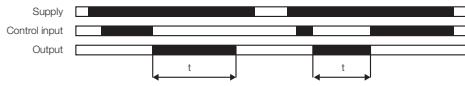

This function requires continuous control supply voltage for timing. The output relay energizes immediately when the control input is de-energized and the output de-energizes after the set pulse time is complete. If control supply voltage is interrupted, the output relay de-energizes and the time delay is reset.

Impulse-OFF without auxiliary voltage

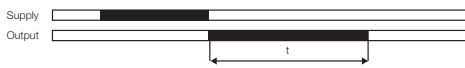

This function does not require continuous control supply voltage for timing. If control supply voltage is interrupted, the output relay energizes and the OFF time starts. When timing is complete, the output relay de-energizes. If control supply voltage is re-applied before the time delay is complete, the time delay is reset and the output relay de-energizes. Control supply voltage must be applied for the minimum energizing time (200 ms), for proper operation.

Impulse-OFF with auxiliary voltage (Trailing edge interval)

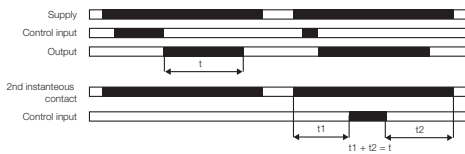

This function requires continuous control supply voltage for timing. If control supply voltage is applied, opening control input energizes the output relay immediately and starts timing. When the selected pulse time is complete, the output relay de-energizes. Closing control input, before the time delay is complete, de-energizes the output relay and resets the time delay. If control supply voltage is interrupted, the output relay de-energizes and the time delay is reset.

Impuls-ON and Impulse-OFF functions

Impulse-ON and impulse-OFF

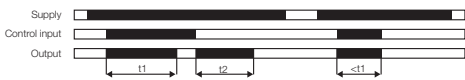

This function requires continuous control supply voltage for timing. If control supply voltage is applied, closing control input energizes the output relay immediately and starts the pulse time t_1 . When t_1 is complete, the output relay de-energize. Re-opening control input energizes the output relay immediately and starts the pulse time t_2 . When t_2 is complete, the output relay de-energizes. t_1 and t_2 are independently adjustable. If control input changes state before the pulse time is complete, the output relay de-energizes and the pulse time is reset. If control input changes state again, the interrupted pulse time restarts. If control supply voltage is interrupted, the output relay de-energizes and the time delay is reset.

Flasher starting with ON functions

Flasher starting with ON



Applying control supply voltage starts timing with symmetrical ON & OFF times. The cycle starts with an ON time first. If control supply voltage is interrupted, the output relay de-energizes and the time delay is reset.

Flasher with reset starting with ON



Applying control supply voltage starts timing with symmetrical ON & OFF times. The cycle starts with an ON time first. The time delay can be reset by closing control input. Opening control input starts the timer pulsing again with symmetrical ON & OFF times. If control supply voltage is interrupted, the output relay de-energizes and the time delay is reset.

Flasher starting with OFF functions

Flasher starting with OFF



Applying control supply voltage starts timing with symmetrical ON & OFF times. The cycle starts with an OFF time first. If control supply voltage is interrupted, the output relay de-energizes and the time delay is reset.

Flasher with reset starting with OFF

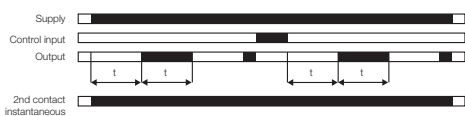

Applying control supply voltage starts timing with symmetrical ON & OFF times. The cycle starts with an OFF time first. The time delay can be reset by closing control input. Opening control input starts the timer pulsing again with symmetrical ON & OFF times. If control supply voltage is interrupted, the output relay de-energizes and the time delay is reset.

Flasher starting with ON or OFF functions

Flasher starting with ON or OFF



Applying control supply voltage starts timing with symmetrical ON / OFF times. If the control input is open during supply voltage is connected the cycle starts with an ON time first. If the control input is closed during supply voltage is connected the cycle starts with an OFF time first.

Electronic timers

Timing functions

1

Pulse former

Pulse former (single shot)



This function requires continuous control supply voltage for timing. Closing control input energizes the output relay immediately and starts timing. Operating the control input during the time delay has no effect. When the selected ON time is complete, the output relay de-energizes. After the ON time is complete, it can be restarted by closing control input. If control supply voltage is interrupted, the output relay de-energizes and the time delay is reset.

Single-pulse former

Single-pulse generator, starting with OFF

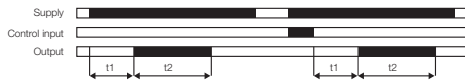

This function requires continuous control supply voltage for timing. Applying control supply voltage, or, if control supply voltage is already applied, opening control input energizes the output relay after the OFF time t_1 is complete. When the following ON time t_2 is complete, the output relay de-energizes. The ON & OFF times are independently adjustable. Closing control input with control supply voltage applied, de-energizes the output relay and resets the time delay. If control supply voltage is interrupted, the output relay de-energizes and the time delay is reset.

Impulse with delay

Fixed impulse with adjustable time delay

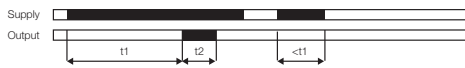

This function requires continuous control supply voltage for timing. The time delay t_1 starts when control supply voltage is applied. When t_1 is complete, the output relay energizes for the fixed impulse time t_2 of 500 ms. If control supply voltage is interrupted, the time delay is reset. The output relay does not change state.

Adjustable impulse with fixed time delay



This function requires continuous control supply voltage for timing. Applying control supply voltage starts the fixed time delay t_2 of 500 ms. When t_2 is complete, the output relay energizes and the selected pulse time t_1 starts. When t_1 is complete, the output relay de-energizes. If control supply voltage is interrupted, the pulse time is reset. The output relay does not change state.

ON- and OFF-delay

ON- and OFF-delay



This function requires continuous control supply voltage for timing. Closing the control input the ON delay starts. After the ON delay time is elapsed the output energizes. Opening the control input let the OFF delays time start. When the OFF delay time is elapsed the output de-energizes again. Operating the control input during timing will reset the respective timing function.

Symmetrical ON- and OFF-delay

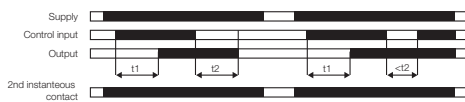

This function requires continuous control supply voltage for timing. Closing control input starts the ON-delay time t_1 . When timing is complete, the output relay energizes. Opening control input starts the OFF-delay time t_2 . When the OFF-delay t_2 is complete, the output relay de-energizes. If control input opens before the ON-delay t_1 is complete, the time delay is reset and the output relay remains de-energized. If control input closes before the OFF-delay time t_2 is complete, the time delay is reset and the output relay remains energized.

Asymmetrical ON- and OFF-delay

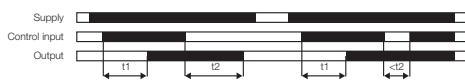

This function requires continuous control supply voltage for timing. Closing control input starts the ON-delay t_1 . When timing is complete, the output relay energizes. Opening control input starts the OFF-delay t_2 . When the OFF-delay is complete, the output relay de-energizes. The ON-delay and OFF-delay are independently adjustable. If control input opens before the ON-delay is complete ($<t_1$), the time delay is reset and the output relay remains de-energized. If control input closes before the OFF-delay is complete ($<t_2$), the time delay is reset and the output relay remains energized. If control supply voltage is interrupted, the output relay de-energizes and the time delay is reset.

Electronic timers

Timing functions

Further functions



This function is used for test purposes during commissioning and troubleshooting.
 If the selected max. value of the time range is smaller than 300 h (front-face potentiometer "Time sector" ≠ 300 h), applying control supply voltage energizes the output relay immediately. Interrupting control supply voltage, de-energizes the output relay.
 If the selected max. value of the time range is 300 h (front-face potentiometer "Time sector" = 300 h) and control supply voltage is applied the output relay does not energize.

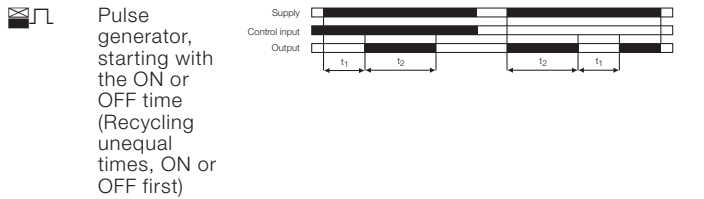

This function requires continuous control supply voltage for timing. Applying control supply voltage, with open control input, starts timing with an ON time first. Applying control supply voltage, with closed control input, starts timing with an OFF time first. If control supply voltage is interrupted, the output relay de-energizes and the time delay is reset.

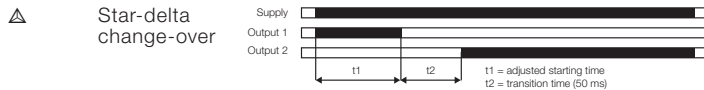

Applying control supply voltage energizes the star contactor and begins the set starting time. When the starting time is complete the star contactor de-energizes. Now, the fix transition time starts. When the transition time is complete, the delta contactor energizes.

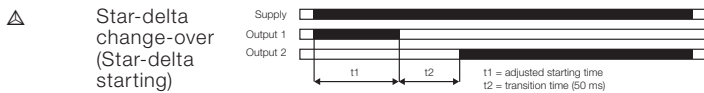

This function requires continuous control supply voltage for timing. Applying control supply voltage, energizes the star contactor and begins the set starting time t1. When the starting time is complete, the first output contact de-energizes the star contactor. When the transition time t2 is complete, the second output contact energizes the delta contactor. The delta contactor remains energized as long as control supply voltage is applied.

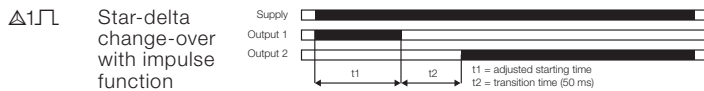

This function requires continuous control supply voltage for timing. Applying control supply voltage energizes the star contactor connected to output 1 and begins the set starting time t1. When the starting time is complete, the first output de-energizes the star contactor. Now, the fixed transition time t2 of 50 ms starts. When the transition time is complete, the second output energizes the delta contactor. The delta contactor remains energized as long as control supply voltage is applied.