

Zelio Relays

Electromechanical relays

Catalog

December 2018



Quick access to product information

Get technical information about your product

References (continued) **Transformers**
Phaseo ABT7, ABL6

Transformers with phase-to-neutral (N-L1) or phase-to-phase (L1-L2) connection (continued)					
Input voltage	Secondary Type	Rated power	Reference	Weight	Height
Transformers 220/400 V, Double winding					
With cover, connected by internal jumpers with LED indicators					
230/400 V	On-load energy: 2 x 24 V	40 VA	ABT7PDU0048	1.400/2.108	
400 V		63 VA	ABT7PDU0058	1.940/2.717	
100 VA		100 VA	ABT7PDU0108	2.900/3.505	
100 VA		100 VA	ABT7PDU0158	4.400/3.700	
250 VA		250 VA	ABT7PDU0208	5.900/2.248	
300 VA		300 VA	ABT7PDU0228	7.100/15.403	
3 x 115 V					
25 VA		25 VA	ABT7PDU0025	1.100/2.225	
40 VA		40 VA	ABT7PDU0045	1.400/2.108	
63 VA		63 VA	ABT7PDU0055	1.940/2.717	
100 VA		100 VA	ABT7PDU0105	2.900/3.505	
100 VA		100 VA	ABT7PDU0155	4.400/3.700	
250 VA		250 VA	ABT7PDU0205	5.900/2.248	
300 VA		300 VA	ABT7PDU0225	7.100/15.403	

Each commercial reference presented in this catalog contains a hyperlink. Click on it to obtain the technical information of the product:

- > Characteristics, Dimensions and drawings, Mounting and clearance, Connections and schemas, Performance curves
- > Product image, Instruction sheet, User guide, Product certifications, End of life manual

Find your catalog

- > With just 3 clicks, you can reach the Industrial Automation and Control catalogs, in both English and French.
- > Download Digi-Cat with this [link](#)

Select your training



- > Find the right Training for your needs on our Global website
- > Locate the training center with the selector tool, using this [link](#)

General contents

General presentation and selection guide...

1

Plug-in relays and relays with clamp fixing...

2

Product reference index.....

3

Zelio Relays - Electromechanical relays

■ General presentation

- Zelio RSL relays for compactness..... page 1/2
- Zelio RXG relays for reliability..... page 1/2
- Zelio RXM relays for automation control..... page 1/3
- Selection guide of Plug-in relays and relays with clamp fixing page 1/4**



1

Zelio Relays - Electromechanical Relays

Used to multiply the number of input and output contacts, or for logic processing control

RSL relays are compact modular relays conforming to IEC/EN 61810-1, UL508, CSA C22.2 No. 14, and EAC international standards.

Zelio Relays offer interface, miniature, universal, and power electromechanical relays, from 1 CO to 4 CO contacts, up to 30 A. The electromechanical relays help to reduce the size of enclosures and at the same time increase machine reliability.

RSL relays for compactness

Flexible offer

- > Available as a single-referenced complete product (relay and socket) or customer-assembled product
- > Wide choice of sockets ranging from 12 to 230 V ~
- > Standard and low level contact types

Enhanced performance

- > Sockets with integrated reverse polarity protection circuit
- > Relays for high breaking capacity or low-level current application requirements
- > Power-on and Relay status LED indicator

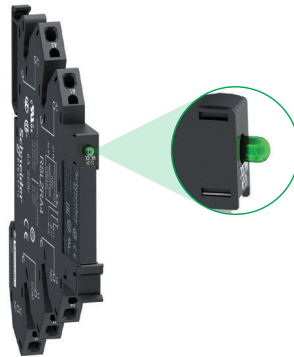

LED indicator for RSL relay status

Simple installation and cabling

- > Locking/unlocking lever for removing and replacing the relay in the socket
- > Simple DIN rail mounting and commoning link accessory
- > Choice of screw connector or spring terminal connection for sockets

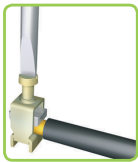

Screw connector



Spring terminal

RXG relays for reliability

Complete offer

RXG relays offer a broad range of coil voltages, from 6 V to 110 V \pm and 24 V to 230 V ~. The relays are available with/without lockable test button, LED, and clear cover.



Easy to mount and use

These are the latest relays with a single-step lockable test button. The Faston pin terminal mounts quickly and securely. The slim 16 mm/0.629 in. socket for 2 CO saves panel space.



Single-step lockable test button

Zelio Relay RXG → Latest interface relay with easy testing function

RXG relays for reliability (continued)

Expandable relays

RXG relays can be expanded with protection modules such as diode, diode with LED, varistor with LED, and RC circuit.

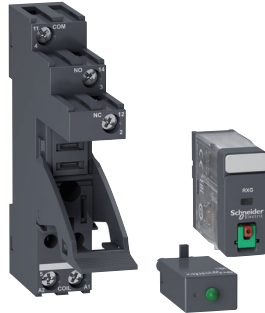

RXM relays industrial relays bring features for easy and improved control of simple and complex automation systems.

RXM relays for automation control

Easy to select

- > Wider choice of contacts (2, 3, and 4 CO)
- > Broad range of control circuit voltages and different socket types
- > Configurator available in Apple App and Android Play Store



Convenient to use

- > One-step lockable test button
- > Mechanical indicator for contact status
- > "Power On" LED for readiness

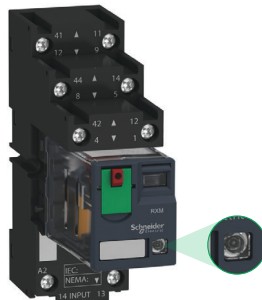

LED indicator for relay status



Push and stay spring clamp terminal: insert without tool

Simple to install

- > Push and stay spring clamp socket wiring (no screwdriver required) provides up to 65% time saving
- > Sockets for both DIN rail and panel mounting, time-saving bus jumper
- > Direct mounting with DIN rail or flange adapter

Designed to perform

- > Eco-design with RoHS and REACH
- > Flexible add-on protection modules
- > Spring clamp socket with 20 kg/44 lb wire pull-out force and reliable retention force on cables

Zelio Relay - Electromechanical relays

Plug-in relays and relays with clamp fixing

Type of product

Plug-in relays
Slim interface relays

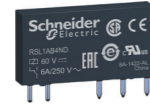

Number and type of contacts/conventional thermal current (Ith on NO contact)		1 CO / 6 A
Control circuit voltage		-
Pin type		Flat (PCB type, reinforced)
Operational voltage		Up to 400 V ~ / 300 V ≡
Durability (operating cycles per hour)	Electrical, resistive load	60,000
	Mechanical, no-load	10,000,000
Functions	LED	No
	Mechanical indicator	No
	Lockable test button	No
	Contact type	Standard and low level
Type references		RSL1●B4●D (1)
Pages		2/3
Type of associated sockets		Sockets with LED and protection circuit



Contact terminal arrangements		Separate	
Connection		Screw connector	Spring terminals
Accessories	Protection modules	No	No
	Timer module	No	No
	Maintaining clamps	No	No
	Socket identification legend	Yes	Yes
	Mounting adapters for DIN rail	No	No
	Mounting adapters with fixing lugs	No	No
	Bus jumper	Yes, 20-pole	Yes, 20-pole
Conventional thermal current (Ith)		6 A	6 A
Type references		RSLZV●●	RSLZR●●
Pages		2/3	

(1) Pre-assembled interface relays RSL1PV●● and RSL1PR●● (standard type relay + socket), RSB (relay + socket + clamp + protection module + label), and RXG (relay + socket + protection module) are also available.

Plug-in relays
Interface relays



1 CO / 16 A 1 CO / 12 A 2 CO / 8 A		1 CO / 10 A 2 CO / 5 A	
24...240 V		24...230 V	
6...110 V		6...110 V	
Flat (PCB type)		Flat (Faston type)	
Up to 400 V ~ / 300 V ≡		Up to 250 V ~ / ≡	
100,000		100,000	
30,000,000		10,000,000 for AC coil 10,000,000 for DC coil	
Yes (with protection modules)		Yes (depending on version)	
No		Yes (depending on version)	
No		Yes (depending on version)	
Standard		Standard	
RSB●●●●●● (1)		RXG●●●● (1)	
2/5		2/9	
Sockets without LED		Sockets	





Separate		Separate	
Screw connector		Screw connector	
Yes		Yes	
No		No	
Yes		Yes (plastic)	
Yes		Yes	
No		No	
No		No	
Yes		Yes	
12 A	(2 terminals) × 10 A (2)	10 A for 1 CO	5 A for 2 CO
RSZE1S35M	RSZE1S48M	RGZE1S35M	RGZE1S48M
2/5		2/10	

(2) When using relay RSB1A160●● with socket RSZE1S48M, terminals must be linked.

Zelio Relays - Electromechanical relays

Plug-in relays and relays with clamp fixing

Type of product		Plug-in relays	
		Miniature relays	
			
Number and type of contacts/conventional thermal current (Ith on NO contact)		2 CO / 12 A 3 CO / 10 A 4 CO / 6 A 4 CO / 3 A (low level)	
Control circuit voltage		24...240 V 12...220 V	
Pin type		Flat (Faston type)	
Operational voltage		Up to 250 V ~/∞	
Durability (operating cycles per hour)		Electrical, resistive load Mechanical, no-load	
		100,000 10,000,000	
Functions		LED Mechanical indicator Lockable test button Contact type	
Type references		RXM●●●●● (1)	
Pages		2/13	
Type of associated sockets		Sockets without LED	

					
Contact terminal arrangements		Mixed		Separate	
Connection		Screw connector		Screw clamp terminals	
Accessories		Protection modules		Timer module	
		Maintaining clamps		Socket identification legend	
		Mounting adapters for DIN rail		Mounting adapters with fixing lugs	
		Bus jumper			
Conventional thermal current (Ith)		10 A		10 A	
		12 A for 2 CO (2) 6 A for 4 CO		12 A for 2 CO 6 A for 4 CO	
Type references		RXZE2M114M		RXZE2M114	
		RXZE2S●●●M		RXZE2S114S	
Pages		2/15			

(1) Pre-assembled miniature relays RXM (relay + socket + clamp + label) are also available.
(2) Except for sockets RXZE2S11●M: 10 A.

Plug-in relays		Universal relays		Relays with clamp fixing	
Power relays				Power relays	
					
1 CO / 15 A 2 CO / 15 A 3 CO / 15 A 4 CO / 15 A		2 CO / 10 A 3 CO / 10 A		2 CO / 10 A 3 CO / 10 A	
		24...230 V		2 NO / 30 A (4) 2 CO / 30 A (4)	
12...110 V		12...220 V		12...110 V	
Flat (Faston type)		Cylindrical		Flat (Faston type)	
Up to 250 V ~/∞		Up to 250 V ~/∞		Up to 250 V ~/∞	
100,000 (3) 10,000,000		100,000 5,000,000		100,000 5,000,000	
Yes (depending on version) Yes Yes Standard		Yes (depending on version) Yes Yes Low level (depending on version)		Standard -	
RPM●●●●		RUM●●●●		RPF●●●●	
2/21		2/17		2/25	
Sockets without LED		Sockets without LED			

					
Contact terminal arrangements		Mixed		Mixed	
Connection		Screw clamp terminals		Screw connector	
Accessories		Yes		Yes	
		Yes (for 3- and 4-pole)		Yes	
		Yes (on socket RPZF1)		Yes	
		Yes		Yes	
		Yes		No	
		Yes		No	
		No		Yes, 2-pole (Ith = 5 A)	
Conventional thermal current (Ith)		16 A		12 A	
Type references		RPZF●		RUZC●M	
		RUZSC●M		RUZSF3M	
Pages		2/22			

(3) 100,000 for RPM1 and RPM2; 60,000 for RPM3 and RPM4.
(4) 30 A when mounted with 13 mm (0.51 in.) gap between two relays and 25 A when mounted side by side without a gap.

RSL slim interface relays

■ Presentation

- Presentation of the range..... page 2/2
- Relay description page 2/2
- Socket description page 2/2

■ References

- Pre-assembled slim interface relays page 2/3
- Slim interface relays for customer assembly page 2/3
- Accessories for sockets page 2/3

RSB interface relays

■ Presentation

- Presentation of the range..... page 2/4
- Socket description page 2/4

■ References

- Pre-assembled interface relays page 2/5
- Interface relays for customer assembly page 2/6
- Sockets with separate contact terminal arrangement and connector connection..... page 2/6
- Protection modules page 2/6
- Accessories page 2/7

RXG interface relays

■ Presentation

- Presentation of the range..... page 2/8
- Relay description page 2/8
- Socket description page 2/8

■ References

- Pre-assembled interface relays page 2/9
- Interface relays for customer assembly page 2/9
- Sockets with separate contact terminals, screw connector connection, and built-in clamp page 2/11
- Protection modules page 2/11
- Accessories page 2/11

RXM miniature relays

■ Presentation

- Presentation of the range..... page 2/12
- Relay description page 2/12
- Socket description page 2/12

■ References

- Pre-assembled interface relays page 2/13
- Miniature relays for customer assembly..... page 2/14
- Sockets..... page 2/15
- Protection modules page 2/15
- Timing relays page 2/15
- Accessories page 2/15

RUM universal relays

■ Presentation

- Presentation of the range..... page 2/16
- Relay description page 2/16
- Socket description page 2/16

■ References page 2/17

- Universal relays for customer assembly page 2/17
- Sockets..... page 2/18
- Protection modules..... page 2/18
- Timer module..... page 2/18
- Timing relays page 2/18
- Accessories page 2/19

RPM power relays

■ Presentation

- Presentation of the range..... page 2/20
- Relay description page 2/20
- Socket description page 2/20

■ References page 2/21

- Power relays for customer assembly page 2/21
- Sockets..... page 2/22
- Protection modules..... page 2/22
- Timer module..... page 2/22
- Accessories page 2/23

RPF power relays

■ Presentation..... page 2/24

■ References page 2/25

Technical presentation

- Relays..... page 2/26
- Protection modules page 2/27

Presentation of the range

RSL slim interface relays offer the advantages of compact size and modular design. Their slim width (6 mm/0.236 in.) saves space when mounting on a DIN rail at the back of an enclosure.

RSL relays are available as:

- **Pre-assembled offer:** a single reference comprising a standard relay mounted on its socket.
 - The socket includes a protection circuit (against reverse polarity and surge) and an LED indicator as standard.
 - 2 types of connector are available for wire connection: screw connectors or spring terminals.
 - This pre-assembled solution covers a wide range of operating voltages from 12 to 230 V.
- **Customer assembly offer:**
 - The relay (standard or low level) and the socket are selected, as required, according to the operating voltage of the application.
 - For maintenance, an RSL slim relay can be replaced without disconnecting the socket wiring.

Relay description

RSL slim interface relays, pre-assembled

- 1 6 A standard relay with 1 CO contact
- 2 Lever for retaining or easy withdrawal of the relay from its socket
- 3 Sockets: wire connection by screw connectors or spring terminals
- 4 Built-in protection circuit and LED indicator on all sockets

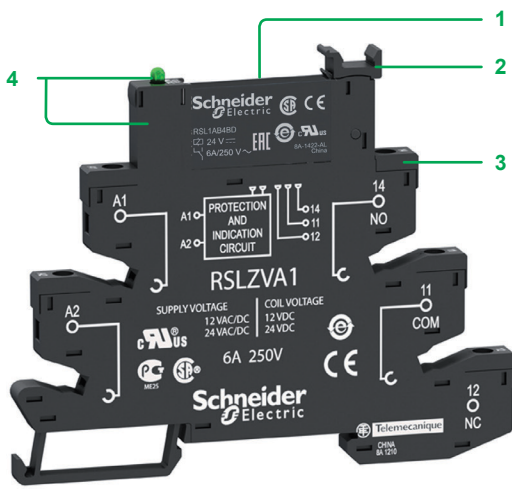

RSL slim interface relay

- 1 5 flat (PCB type) standard pins

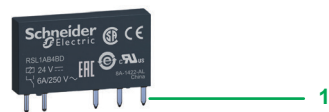

Socket description

Sockets for RSL slim interface relays

- 1 5 female contacts for the relay pins
- 2 Retaining lever with marker label
- 3 Wire connection by screw connectors or spring terminals
- 4 Built-in protection circuit and LED indicator
- 5 Locating slot for mounting on DIN rail

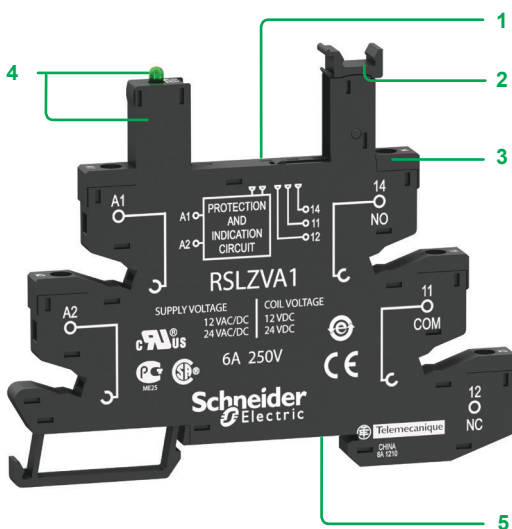



RSL1PVBU RSL1PRPU

Pre-assembled slim interface relays					
Standard relays mounted on socket equipped with LED and protection circuit					
1 CO contact - Thermal current (Ith) 6A					
Operating voltage	Control circuit voltage	Socket type		Spring terminal	
		Screw connector	Weight	Unit reference	Weight
V	V	Unit reference	kg/lb	Unit reference	kg/lb
~/~ 12	~ 12	RSL1PVJU (RSL1AB4JD + RSLZVA1)	0.031/0.068	RSL1PRJU (RSL1AB4JD + RSLZRA1)	0.029/0.064
~/~ 24	~ 24	RSL1PVBU (RSL1AB4BD + RSLZVA1)	0.031/0.068	RSL1PRBU (RSL1AB4BD + RSLZRA1)	0.029/0.064
~/~ 48	~ 48	RSL1PVEU (RSL1AB4ED + RSLZVA2)	0.031/0.068	RSL1PREU (RSL1AB4ED + RSLZRA2)	0.029/0.064
~/~ 110	~ 60	RSL1PVFU (RSL1AB4ND + RSLZVA3)	0.031/0.068	RSL1PRFU (RSL1AB4ND + RSLZRA3)	0.029/0.064
~/~ 230	~ 60	RSL1PVPU (RSL1AB4ND + RSLZVA4)	0.031/0.068	RSL1PRPU (RSL1AB4ND + RSLZRA4)	0.029/0.064



RSL1AB4ND

Slim interface relays for customer assembly				
Relays with flat (PCB type) standard pins				
1 CO contact - Thermal current (Ith) 6A				
Control circuit voltage	Standard		Low level	
	Unit reference	Weight	Unit reference	Weight
V		kg/lb		kg/lb
~ 12	RSL1AB4JD	0.006/0.013	RSL1GB4JD	0.006/0.013
~ 24	RSL1AB4BD	0.006/0.013	RSL1GB4BD	0.006/0.013
~ 48	RSL1AB4ED	0.006/0.013	RSL1GB4ED	0.006/0.013
~ 60	RSL1AB4ND	0.006/0.013	RSL1GB4ND	0.006/0.013



RSLZVA RSLZRA

Sockets equipped with LED and protection circuit					
Sold in lots of 10					
Operating voltage	For use with relays	Socket type		Spring terminal	
		Screw connector	Weight	Unit reference	Weight
V		Unit reference	kg/lb	Unit reference	kg/lb
~/~ 12 and ~/~ 24	RSL1●B4JD RSL1●B4BD	RSLZVA1	0.025/0.055	RSLZRA1	0.023/0.051
~/~ 48 and ~/~ 60	RSL1●B4ED RSL1●B4ND	RSLZVA2	0.025/0.055	RSLZRA2	0.023/0.051
~/~ 110	RSL1●B4ND	RSLZVA3	0.025/0.055	RSLZRA3	0.023/0.051
~/~ 230	RSL1●B4ND	RSLZVA4	0.025/0.055	RSLZRA4	0.023/0.051

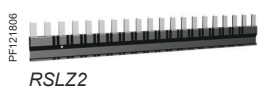

RSLZ2



RSLZ3

Socket accessories			
Description	For use with	Reference	Weight
			kg/lb
Clip-in legends (2 sheets of 64 legends)	All sockets	RSLZ5	0.001/0.002
Bus jumper (10 x 20-pole jumper)	All sockets	RSLZ2	0.003/0.007
Partition plate (10 partition plates)	All sockets	RSLZ3	0.001/0.002

2

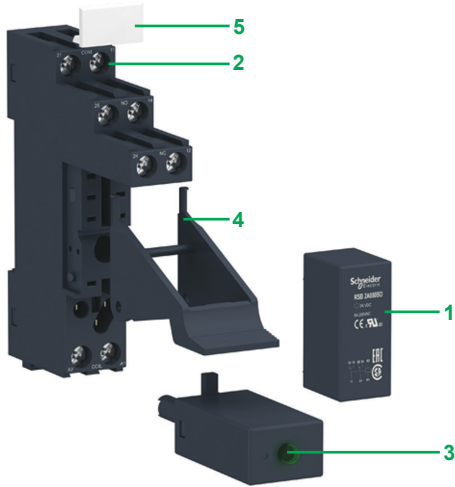

Presentation of the range

The RSB interface relay range comprises:

- 1 12 A relays with 1 CO contact , 16 A relays with 1 CO contact, and 8 A relays with 2 CO contacts
- 2 Sockets with separate contact terminals
- 3 Protection modules (diode, diode + LED, RC circuit, or varistor + LED) common to all sockets
- 4 A plastic maintaining clamp for all sockets
- 5 Clip-in legend for all sockets

These relays are available in both pre-assembled (single reference) and customer assembled offers.

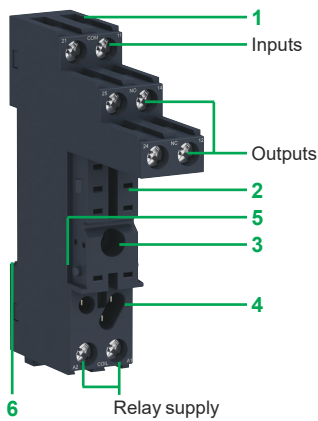

Socket description

Sockets with separate contact terminals (1)

- 1 Connection by connector
- 2 5 or 8 female contacts for the relay pins
- 3 Hole for panel mounting
- 4 Location for protection modules
- 5 Locking components for plastic maintaining clamp
- 6 Locating slot for mounting on DIN rail

(1) The inputs and outputs are separate from the relay supply.



RSB2A080F7PV

Pre-assembled interface relays

Relays mounted on sockets with protection module (LED version) and integrated clamp
(sold in lots of 30)

Control circuit voltage	Number and types of contact - Thermal current (Ith)					
	1 CO - 12 A		1 CO - 16 A		2 CO - 8 A	
	Unit Reference	Weight	Unit Reference	Weight	Unit Reference	Weight
V		kg/lb		kg/lb		kg/lb
12 $\overline{\sim}$	RSB1A120JDPV (RSB1A120JD + RSZE1S35M + RSZR215 + RZM031RB + RSZL300)	0.050/ 0.110			RSB2A080JDPV (RSB2A080JD + RSZE1S48M + RSZR215 + RZM031RB + RSZL300)	0.057/ 0.126
24 $\overline{\sim}$	RSB1A120BDPV (RSB1A120BD + RSZE1S35M + RSZR215 + RZM031RB + RSZL300)	0.050/ 0.110	RSB1A160BDPV (RSB1A160BD + RSZE1S48M + RSZR215 + RZM031RB + RSZL300)	0.057/ 0.126	RSB2A080BDPV (RSB2A080BD + RSZE1S48M + RSZR215 + RZM031RB + RSZL300)	0.057/ 0.126
24 \sim	RSB1A120B7PV (RSB1A120B7 + RSZE1S35M + RSZR215 + RZM021RB + RSZL300)	0.050/ 0.110			RSB2A080B7PV (RSB2A080B7 + RSZE1S48M + RSZR215 + RZM021RB + RSZL300)	0.057/ 0.126
120 \sim	RSB1A120F7PV (RSB1A120F7 + RSZE1S35M + RSZR215 + RZM021FP + RSZL300)	0.050/ 0.110			RSB2A080F7PV (RSB2A080F7 + RSZE1S48M + RSZR215 + RZM021FP + RSZL300)	0.057/ 0.126
220 \sim					RSB2A080M7PV (RSB2A080M7 + RSZE1S48M + RSZR215 + RZM021FP + RSZL300)	0.057/ 0.126
230 \sim	RSB1A120P7PV (RSB1A120P7 + RSZE1S35M + RSZR215 + RZM021FP + RSZL300)	0.050/ 0.110	RSB1A160P7PV (RSB1A160P7 + RSZE1S48M + RSZR215 + RZM021FP + RSZL300)	0.057/ 0.126	RSB2A080P7PV (RSB2A080P7 + RSZE1S48M + RSZR215 + RZM021FP + RSZL300)	0.057/ 0.126

2



RSB1A120JD + RZM031RB + RSZE1S35M



RSB1A160JD + RSZE1S48M

Interface relays for customer assembly

RSB interface relays for standard applications (sold in lots of 10)

Control circuit voltage	Number and type of contacts - Thermal current (Ith)			Weight kg/lb
	1 CO - 12 A Unit reference (1)	1 CO - 16 A Unit reference (1)	2 CO - 8 A Unit reference (1)	
V				kg/lb
≡ 6	RSB1A120RD	RSB1A160RD	RSB2A080RD	0.014/0.031
≡ 12	RSB1A120JD	RSB1A160JD	RSB2A080JD	0.014/0.031
≡ 24	RSB1A120BD	RSB1A160BD	RSB2A080BD	0.014/0.031
≡ 48	RSB1A120ED	RSB1A160ED	RSB2A080ED	0.014/0.031
≡ 60	RSB1A120ND	RSB1A160ND	RSB2A080ND	0.014/0.031
≡ 110	RSB1A120FD	RSB1A160FD	RSB2A080FD	0.014/0.031
~ 24	RSB1A120B7	RSB1A160B7	RSB2A080B7	0.014/0.031
~ 48	RSB1A120E7	RSB1A160E7	RSB2A080E7	0.014/0.031
~ 120	RSB1A120F7	RSB1A160F7	RSB2A080F7	0.014/0.031
~ 220	RSB1A120M7	RSB1A160M7	RSB2A080M7	0.014/0.031
~ 230	RSB1A120P7	RSB1A160P7	RSB2A080P7	0.014/0.031
~ 240	RSB1A120U7	RSB1A160U7	RSB2A080U7	0.014/0.031

Sockets with separate contact terminal arrangement and connector connection

Rated insulation voltage	Thermal current (Ith)	Relay type	Sold in lots of	Unit reference	Weight kg/lb
~ 250 V	12 A	RSB1A120●●	10	RSZE1S35M	0.060/0.132
	10 A (2)	RSB1A160●● (3) RSB2A080●●	10	RSZE1S48M	0.050/0.110

Protection modules

Description	For use with	Voltage	Sold in lots of	Unit reference	Weight kg/lb
		V			
Diode	All sockets	≡ 6...230	10	RZM040W	0.003/0.007
RC circuit	All sockets	~ 24...60	10	RZM041BN7	0.010/0.022
		~ 110...240	10	RZM041FU7	0.010/0.022
Diode + green LED	All sockets	≡ 6...24	10	RZM031RB	0.004/0.009
		≡ 24...60	10	RZM031BN	0.004/0.009
		≡ 110...230	10	RZM031FPD	0.004/0.009
Varistor + green LED	All sockets	≡ or ~ 6...24	10	RZM021RB	0.005/0.011
		≡ or ~ 24...60	10	RZM021BN	0.005/0.011
		≡ or ~ 110...230	10	RZM021FP	0.005/0.011

(1) To order a relay complete with socket (sold in lots of 20), add the suffix **S** to one of the following voltage codes: **JD, BD, B7, P7, or F7**. Example: **RSB2A080BD + RSZE1S48M** becomes **RSB2A080BDS**.
 (2) **RSZE1S48M** is a two terminal socket each carrying 10 A.
 (3) If **RSZE1S48M** socket terminals are linked, relay **RSB1A160●●** can be used up to 16 A. See "Wiring diagrams" on www.schneider-electric.com.



RSZR215



RGZS08

RS_532_CP8CT17003-8B-Q

Accessories				
Description	For use with	Sold in lots of	Unit reference	Weight kg/lb
Plastic maintaining clamp	All sockets	10	RSZR215	0.002/0.004
Legend	All sockets	10	RSZL300	0.001/0.002
Bus jumper (10 x 8-pole jumper)	For inputs (A1, A2) of RSZE sockets	10	RGZS08	0.006/0.013

2

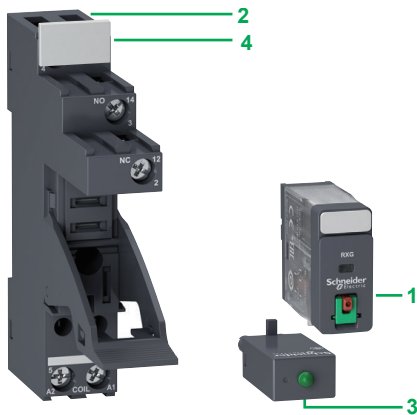

Presentation of the range

RXG relays are interface plug-in relays with Faston pins for better reliability and robust installation. They are used in PLC applications.

The RXG interface relay range comprises:

- 10 A relays with 1 CO contact and 5 A relays with 2 CO contacts
- Sockets with separate contact terminals, screw connector connection, and built-in plastic maintaining clamp
- Protection modules (diode, diode + LED, RC circuit, or varistor + LED) common to all RXG sockets
- Clip-in legends for all RXG sockets

These relays are available in both pre-assembled (single reference) and customer assembled offers.

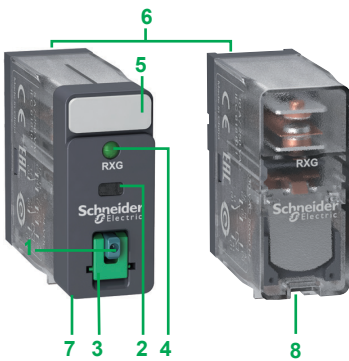

Relay description

- Spring-return pushbutton for testing the contacts (green: --- , red: \sim)
- Mechanical "relay status" indicator
- Removable lock-down door enabling forced maintaining of the contacts for test sequences or maintenance purposes
- LED (depending on version) indicating the relay status
- Removable legend for relay identification
- 5 or 8 Faston type pins
- Standard cover-type relay with pushbutton, mechanical indicator, and LED options
- Clear cover-type relay

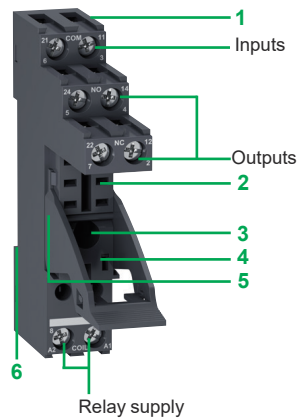

Socket description

Sockets with separate contact terminals (1)

- Connection by connector
- 5 or 8 female contacts for the relay pins
- Hole for panel mounting
- Location for protection modules
- Built-in plastic maintaining clamp for locking components
- Locating slot for mounting on DIN rail

(1) The inputs and outputs are separate from the relay supply.



Pre-assembled interface relays					
Relays with lockable test button and LED, mounted on sockets with protection module and integrated clamp					
Control circuit voltage	Sold in lots of	Number and type of contacts - Thermal current (Ith)		Weight	Weight
		1 CO - 10 A	2 CO - 5 A		
V		Unit reference	Unit reference	kg/lb	kg/lb
24 $\overline{\text{---}}$	30	RXG12BDPV (RXG12BD + RGZE1S35M + RZM031RB)	RXG22BDPV (RXG22BD + RGZE1S48M + RZM031RB)	0.059/0.130	0.066/0.145
24 \sim	30	RXG12B7PV (RXG12B7 + RGZE1S35M + RZM021RB)	RXG22B7PV (RXG22B7 + RGZE1S48M + RZM021RB)	0.059/0.130	0.067/0.148
230 \sim	30	RXG12P7PV (RXG12P7 + RGZE1S35M + RZM021FP)	RXG22P7PV (RXG22P7 + RGZE1S48M + RZM021FP)	0.059/0.130	0.067/0.148

Relays with LED, mounted on sockets with protection module, and integrated clamp and LED					
24 $\overline{\text{---}}$	30	RXG13BDPV (RXG13BD + RGZE1S35M + RZM031RB)	RXG23BDPV (RXG23BD + RGZE1S48M + RZM031RB)	0.058/0.129	0.066/0.145
230 \sim	30	RXG13P7PV (RXG13P7 + RGZE1S35M + RZM021FP)	RXG23P7PV (RXG23P7 + RGZE1S48M + RZM021FP)	0.059/0.130	0.067/0.148

Relays with lockable test button and without LED, mounted on sockets with protection module, and integrated clamp and LED					
24 $\overline{\text{---}}$	30		RXG21BDPV (RXG21BD + RGZE1S48M + RZM031RB)		0.067/0.148
24 \sim	30		RXG21B7PV (RXG21B7 + RGZE1S48M + RZM021RB)		0.067/0.148
230 \sim	30		RXG21P7PV (RXG21P7 + RGZE1S48M + RZM021FP)		0.067/0.148



Interface relays for customer assembly					
Standard cover relays with lockable test button					
6 $\overline{\text{---}}$	10	RXG11RD	RXG21RD		0.020/0.044
12 $\overline{\text{---}}$	10	RXG11JD	RXG21JD		0.020/0.044
24 $\overline{\text{---}}$	10	RXG11BD	RXG21BD		0.020/0.044
48 $\overline{\text{---}}$	10	RXG11ED	RXG21ED		0.020/0.044
60 $\overline{\text{---}}$	10	RXG11ND	RXG21ND		0.020/0.044
110 $\overline{\text{---}}$	10	RXG11FD	RXG21FD		0.020/0.044
24 \sim	10	RXG11B7	RXG21B7		0.020/0.044
48 \sim	10	RXG11E7	RXG21E7		0.020/0.044
120 \sim	10	RXG11F7	RXG21F7		0.020/0.044
220 \sim	10	RXG11M7	RXG21M7		0.020/0.044
230 \sim	10	RXG11P7	RXG21P7		0.020/0.044

2



RXG22B7



RXG13RD

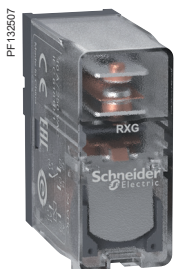

RXG15RD

Interface relays for customer assembly				
Standard cover relays with lockable test button and LED				
Control circuit voltage	Sold in lots of	Number and type of contacts - Thermal current (Ith)		Weight
		1 CO - 10 A	2 CO - 5 A	
V		Unit reference	Unit reference	kg/lb
6 ---	10	RXG12RD	RXG22RD	0.020/0.044
12 ---	10	RXG12JD	RXG22JD	0.020/0.044
24 ---	10	RXG12BD	RXG22BD	0.020/0.044
48 ---	10	RXG12ED	RXG22ED	0.020/0.044
60 ---	10	RXG12ND	RXG22ND	0.020/0.044
110 ---	10	RXG12FD	RXG22FD	0.020/0.044
24 ~	10	RXG12B7	RXG22B7	0.020/0.044
48 ~	10	RXG12E7	RXG22E7	0.020/0.044
120 ~	10	RXG12F7	RXG22F7	0.020/0.044
220 ~	10	RXG12M7	RXG22M7	0.020/0.044
230 ~	10	RXG12P7	RXG22P7	0.020/0.044
Standard cover relays with LED				
6 ---	10	RXG13RD	RXG23RD	0.020/0.044
12 ---	10	RXG13JD	RXG23JD	0.020/0.044
24 ---	10	RXG13BD	RXG23BD	0.020/0.044
48 ---	10	RXG13ED	RXG23ED	0.020/0.044
60 ---	10	RXG13ND	RXG23ND	0.020/0.044
110 ---	10	RXG13FD	RXG23FD	0.020/0.044
24 ~	10	RXG13B7	RXG23B7	0.020/0.044
48 ~	10	RXG13E7	RXG23E7	0.020/0.044
120 ~	10	RXG13F7	RXG23F7	0.020/0.044
220 ~	10	RXG13M7	RXG23M7	0.020/0.044
230 ~	10	RXG13P7	RXG23P7	0.020/0.044
Clear cover relays				
6 ---	10	RXG15RD	RXG25RD	0.019/0.042
12 ---	10	RXG15JD	RXG25JD	0.019/0.042
24 ---	10	RXG15BD	RXG25BD	0.019/0.042
48 ---	10	RXG15ED	RXG25ED	0.019/0.042
60 ---	10	RXG15ND	RXG25ND	0.019/0.042
110 ---	10	RXG15FD	RXG25FD	0.019/0.042
24 ~	10	RXG15B7	RXG25B7	0.018/0.040
48 ~	10	RXG15E7	RXG25E7	0.018/0.040
120 ~	10	RXG15F7	RXG25F7	0.018/0.040
220 ~	10	RXG15M7	RXG25M7	0.018/0.040
230 ~	10	RXG15P7	RXG25P7	0.018/0.040

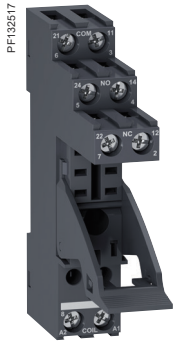

RGZE1S48M



RZM031RB



RSZL300



RGZS08

Sockets with separate contact terminals, screw connector connection, and built-in clamp

Description	Thermal current (I _{th})	Relay type	Sold in lots of	Unit reference	Weight kg/lb
1 CO socket with 1 pole	10 A	RXG1●●●	10	RGZE1S35M	0.034/0.075
2 CO socket with 2 poles	5 A	RXG2●●●	10	RGZE1S48M	0.042/0.093

Protection modules

Description	For use with	Voltage	Sold in lots of	Unit reference	Weight		
		V			kg/lb		
Diode	All sockets	⋯ 6...230	10	RZM040W	0.003/0.007		
		~ 24...60	10			RZM041BN7	0.010/0.022
		~ 110...240	10			RZM041FU7	0.010/0.022
Diode + green LED	All sockets	⋯ 6...24	10	RZM031RB	0.004/0.009		
		⋯ 24...60	10	RZM031BN	0.004/0.009		
		⋯ 110...230	10	RZM031FPD	0.004/0.009		
Varistor + green LED	All sockets	⋯ or ~ 6...24	10	RZM021RB	0.005/0.011		
		⋯ or ~ 24...60	10	RZM021BN	0.005/0.011		
		⋯ or ~ 110...230	10	RZM021FP	0.005/0.011		

Accessories

Description	For use with	Sold in lots of	Unit reference	Weight kg/lb
Plastic maintaining clamp	All sockets	10	RGZR215	0.002/0.004
Legend	All sockets	10	RSZL300	0.001/0.002
Legend	All relays	10	RGZL520	0.001/0.002
Bus jumper (10 x 8-pole jumper)	For inputs (A1, A2) of RGZE sockets	10	RGZS08	0.006/0.013

2

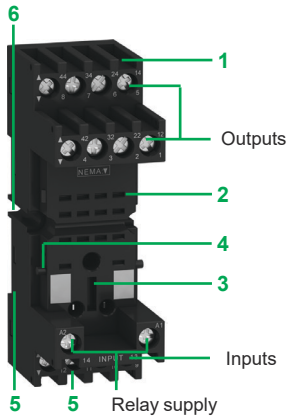
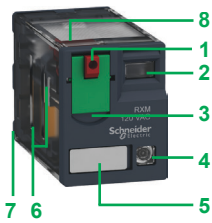
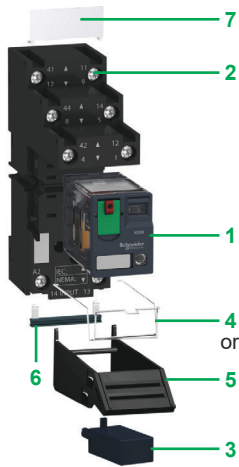

Sockets with mixed contact terminals

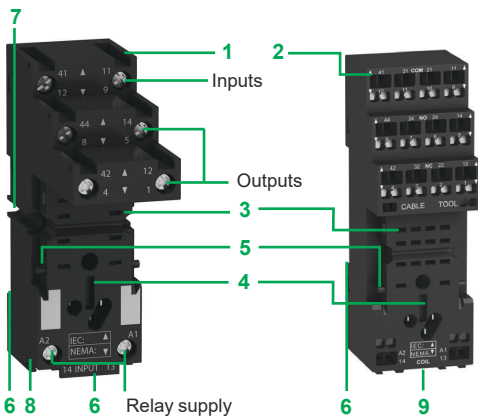

Sockets with separate contact terminals

Presentation of the range

The RXM miniature relay range comprises:

- 1 12 A relays with 2 CO contacts, 10 A relays with 3 CO contacts, 6 A relays with 4 CO contacts, and 3 A "low level" relays with 4 CO contacts (all these relays have the same dimensions)
- 2 Sockets with mixed or separate contact terminals
- 3 Protection modules (diode, RC circuit, or varistor) common to all sockets
- 4 Metal maintaining clamp for all sockets
- 5 Plastic maintaining clamp for all sockets
- 6 2-pole bus jumper that can be used on sockets with separate contact terminals in order to simplify cabling when creating an equipotential link between the coil terminals
- 7 Clip-in legends for all sockets except **RXZE2M114** and **RXZE2S114S**

These relays are available in both pre-assembled (single reference) and customer assembled offers.

Relay description

- 1 Spring-return pushbutton for testing the contacts (green: $\overline{\text{---}}$, red: \sim)
- 2 Mechanical "relay status" indicator
- 3 Removable lock-down door enabling forced maintaining of the contacts for test sequences or maintenance purposes
- 4 LED (depending on version) indicating the relay status
- 5 Removable legend for relay identification
- 6 4 notches for rail mounting adapter or panel mounting adapter with mounting lugs
- 7 8, 11, or 14 Faston type pins
- 8 Area by which the product can be easily gripped
- 9 Mounting adapter enabling direct mounting of the relay on a panel
- 10 Mounting adapter enabling direct mounting of the relay on a DIN rail

Socket description

Sockets with mixed contact terminals (1)

- 1 Connection by screw clamp terminals or screw connector
- 2 14 female contacts for the relay pins
- 3 Location for protection modules
- 4 Locking components for plastic and metal maintaining clamps
- 5 Locating slot for mounting on DIN rail with compression spring or mounting clip
- 6 2 or 4 holes for panel mounting

Sockets with separate contact terminals (2)

- 1 Connection by screw connector
- 2 Connection by push-in spring clamp terminals (no tool \otimes required to insert the cable)
- 3 8, 11, or 14 female contacts for the relay pins
- 4 Location for protection modules
- 5 Locking components for plastic and metal maintaining clamps
- 6 Locating slot for mounting on DIN rail with compression spring or mounting clip
- 7 2 holes for panel mounting
- 8 Location for bus jumpers (see dimensions for mounting on sockets on www.schneider-electric.com)
- 9 Location for clip-in legend

(1) The inputs are mixed with the relay supply, with the outputs being located on the opposite side of the socket.

(2) The inputs and outputs are separate from the relay supply.

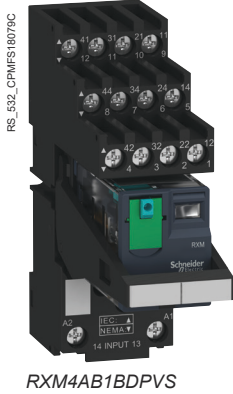

RXM4AB1BDPVS

RS_532_CPMIFS 18079C

Pre-assembled interface relays

Relays without LED, mounted on sockets with clamp and socket legend (sold in lots of 30)

Control circuit voltage	Type of socket	Number and type of contacts - Thermal current (Ith)			
		2 CO - 12 A		4 CO - 6 A	
V		Unit reference	Weight kg/lb	Unit reference	Weight kg/lb
24 ---	Mixed terminal socket	-	-	RXM4AB1BDPVM (RXM4AB1BD + RXZE2M114M + RXZR335 + RXZL520)	0.099/ 0.218
24 ~		-	-	RXM4AB1B7PVM (RXM4AB1B7 + RXZE2M114M + RXZR335 + RXZL520)	0.099/ 0.218
230 ~		-	-	RXM4AB1P7PVM (RXM4AB1P7 + RXZE2M114M + RXZR335 + RXZL520)	0.099/ 0.218
24 ---	Separate terminal socket	-	-	RXM4AB1BDPVS (RXM4AB1BD + RXZE2S114M + RXZR335 + RXZL520)	0.113/ 0.249
24 ~		-	-	RXM4AB1B7PVS (RXM4AB1B7 + RXZE2S114M + RXZR335 + RXZL520)	0.113/ 0.249
230 ~		-	-	RXM4AB1P7PVS (RXM4AB1P7 + RXZE2S114M + RXZR335 + RXZL520)	0.113/ 0.249

Relays with LED, mounted on sockets with clamp and socket legend (sold in lots of 30)

24 ---	Mixed terminal socket	RXM2AB2BDPVM (RXM2AB2BD + RXZE2M114M + RXZR335 + RXZL520)	0.099/ 0.218	RXM4AB2BDPVM (RXM4AB2BD + RXZE2M114M + RXZR335 + RXZL520)	0.099/ 0.218
24 ~		RXM2AB2B7PVM (RXM2AB2B7 + RXZE2M114M + RXZR335 + RXZL520)	0.099/ 0.218	RXM4AB2B7PVM (RXM4AB2B7 + RXZE2M114M + RXZR335 + RXZL520)	0.099/ 0.218
230 ~		RXM2AB2P7PVM (RXM2AB2P7 + RXZE2M114M + RXZR335 + RXZL520)	0.099/ 0.218	RXM4AB2P7PVM (RXM4AB2P7 + RXZE2M114M + RXZR335 + RXZL520)	0.099/ 0.218
24 ---	Separate terminal socket	RXM2AB2BDPVS (RXM2AB2BD + RXZE2S108M + RXZR335 + RXZL520)	0.101/ 0.223	RXM4AB2BDPVS (RXM4AB2BD + RXZE2S114M + RXZR335 + RXZL520)	0.113/ 0.249
24 ~		RXM2AB2B7PVS (RXM2AB2B7 + RXZE2S108M + RXZR335 + RXZL520)	0.101/ 0.223	RXM4AB2B7PVS (RXM4AB2B7 + RXZE2S114M + RXZR335 + RXZL520)	0.113/ 0.249
230 ~		RXM2AB2P7PVS (RXM2AB2P7 + RXZE2S108M + RXZR335 + RXZL520)	0.101/ 0.223	RXM4AB2P7PVS (RXM4AB2P7 + RXZE2S114M + RXZR335 + RXZL520)	0.113/ 0.249



2



RXM2AB1BD



RXM2AB1F7



RXM2AB2ED



RXM2AB2F7



RXM4GB1BD



RXM4GB1P7



RXM4GB2BD



RXM4GB2F7

Miniature relays for customer assembly

RXM miniature relays without LED (sold in lots of 10)

Control circuit voltage	Number and type of contacts - Thermal current (Ith)					
	2 CO - 12 A		3 CO - 10 A		4 CO - 6 A	
	Unit reference	Weight	Unit reference	Weight	Unit reference	Weight
V		kg/lb		kg/lb		kg/lb
~ 12	RXM2AB1JD	0.037/0.082	RXM3AB1JD	0.037/0.082	RXM4AB1JD	0.037/0.082
~ 24	RXM2AB1BD	0.037/0.082	RXM3AB1BD	0.037/0.082	RXM4AB1BD	0.037/0.082
~ 48	RXM2AB1ED	0.037/0.082	RXM3AB1ED	0.037/0.082	RXM4AB1ED	0.037/0.082
~ 110	RXM2AB1FD	0.037/0.082	RXM3AB1FD	0.037/0.082	RXM4AB1FD	0.037/0.082
~ 220	-	-	-	-	RXM4AB1MD	0.037/0.082
~ 24	RXM2AB1B7	0.037/0.082	RXM3AB1B7	0.037/0.082	RXM4AB1B7	0.037/0.082
~ 48	RXM2AB1E7	0.037/0.082	RXM3AB1E7	0.037/0.082	RXM4AB1E7	0.037/0.082
~ 120	RXM2AB1F7	0.037/0.082	RXM3AB1F7	0.037/0.082	RXM4AB1F7	0.037/0.082
~ 230	RXM2AB1P7	0.037/0.082	RXM3AB1P7	0.037/0.082	RXM4AB1P7	0.037/0.082
~ 240	-	-	-	-	RXM4AB1U7	0.037/0.082

RXM miniature relays with LED (sold in lots of 10)

~ 12	RXM2AB2JD	0.037/0.082	RXM3AB2JD	0.037/0.082	RXM4AB2JD	0.037/0.082
~ 24	RXM2AB2BD	0.037/0.082	RXM3AB2BD	0.037/0.082	RXM4AB2BD	0.037/0.082
~ 48	RXM2AB2ED	0.037/0.082	RXM3AB2ED	0.037/0.082	RXM4AB2ED	0.037/0.082
~ 110	RXM2AB2FD	0.037/0.082	RXM3AB2FD	0.037/0.082	RXM4AB2FD	0.037/0.082
~ 125	-	-	-	-	RXM4AB2GD	0.037/0.082
~ 24	RXM2AB2B7	0.037/0.082	RXM3AB2B7	0.037/0.082	RXM4AB2B7	0.037/0.082
~ 48	RXM2AB2E7	0.037/0.082	RXM3AB2E7	0.037/0.082	RXM4AB2E7	0.037/0.082
~ 120	RXM2AB2F7	0.037/0.082	RXM3AB2F7	0.037/0.082	RXM4AB2F7	0.037/0.082
~ 230	RXM2AB2P7	0.037/0.082	RXM3AB2P7	0.037/0.082	RXM4AB2P7	0.037/0.082

RXM miniature relays with low level contacts, without LED (sold in lots of 10)

Control circuit voltage	Number and type of contacts Thermal current (Ith)	
	4 CO - 3 A	Weight
V	Unit reference	kg/lb
~ 12	RXM4GB1JD	0.037/0.082
~ 24	RXM4GB1BD	0.037/0.082
~ 48	RXM4GB1ED	0.037/0.082
~ 110	RXM4GB1FD	0.037/0.082
~ 24	RXM4GB1B7	0.037/0.082
~ 48	RXM4GB1E7	0.037/0.082
~ 120	RXM4GB1F7	0.037/0.082
~ 230	RXM4GB1P7	0.037/0.082

RXM miniature relays with low level contacts, with LED (sold in lots of 10)

~ 12	RXM4GB2JD	0.037/0.082
~ 24	RXM4GB2BD	0.037/0.082
~ 48	RXM4GB2ED	0.037/0.082
~ 60	RXM4GB2ND	0.037/0.082
~ 110	RXM4GB2FD	0.037/0.082
~ 125	RXM4GB2GD	0.037/0.082
~ 220	RXM4GB2MD	0.037/0.082
~ 24	RXM4GB2B7	0.037/0.082
~ 48	RXM4GB2E7	0.037/0.082
~ 120	RXM4GB2F7	0.037/0.082
~ 230	RXM4GB2P7	0.037/0.082
~ 240	RXM4GB2U7	0.037/0.082

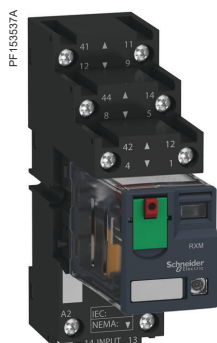

RXZE2S108M
+
Relay RXM4AB1F7



RXM041●●7



REXL4●●



RXZS2

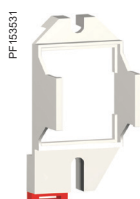

RXZE2DA



RXZ400



RXZL520

Sockets					
Contact terminal arrangement	Connection	Relay type	Sold in lots of	Unit reference	Weight kg/lb
Mixed	Screw clamp terminals	RXM2●●●●● (3) RXM4●●●●●	10	RXZE2M114 (1)	0.048/0.106
	Screw connector	RXM2●●●●● (3) RXM4●●●●●	10	RXZE2M114M (1)	0.056/0.124
Separate	Spring clamp terminals	RXM2●●●●● (3) RXM4●●●●●	10	RXZE2S114S (2)	0.070/0.154
	Screw connector	RXM2●●●●●	10	RXZE2S108M (2)	0.058/0.128
		RXM3●●●●●	10	RXZE2S111M (1)	0.066/0.146
		RXM4●●●●●	10	RXZE2S114M (1)	0.070/0.154

Protection modules					
Description	Voltage	For use with	Sold in lots of	Unit reference	Weight kg/lb
	V				
Diode	~ 6...250	All sockets	10	RXM040W	0.003/0.007
RC circuit	~ 24...60	All sockets	10	RXM041BN7	0.010/0.022
	~ 110...240	All sockets	10	RXM041FU7	0.010/0.022
Varistor	~ 6...24	All sockets	10	RXM021RB	0.030/0.066
	~ 24...60	All sockets	10	RXM021BN	0.030/0.066
	~ 110...240	All sockets	10	RXM021FP	0.030/0.066

Timing relays				
Description	For use with	Unit reference	Weight kg/lb	
2 or 4 timed CO contacts (function A)	RXZE●●●●● sockets	REXL2●● (4) REXL4●● (4)	—	—

Accessories				
Description	For use with	Sold in lots of	Unit reference	Weight kg/lb
Metal maintaining clamp	All sockets	10	RXZ400	0.001/0.002
Plastic maintaining clamp	All sockets	10	RXZR335	0.005/0.011
2-pole bus jumper (Ith: 5 A)	All sockets with separate contacts	10	RXZS2	0.005/0.011
Mounting adapter for 1/2 rails (5)	All relays	10	RXZE2DA	0.004/0.009
Mounting adapter with panel mounting lugs	All relays	10	RXZE2FA	0.002/0.004
Clip-in legends	All relays (sheet of 108 legends)	10	RXZL520	0.080/0.176
	All sockets except RXZE2M114 and RXZE2S114S	10	RXZL420	0.001/0.002
	RXZE2S114S socket	10	RSZL300	0.001/0.002

(1) Thermal current (Ith): 10 A.

(2) Thermal current (Ith): 12 A.

(3) When mounting relay RXM2●●●●● on socket RXZE2M●●●●●, the thermal current should not exceed 10 A.

(4) Please refer to "Zelio Time timing relays" catalog.

(5) Test button becomes inaccessible.

2

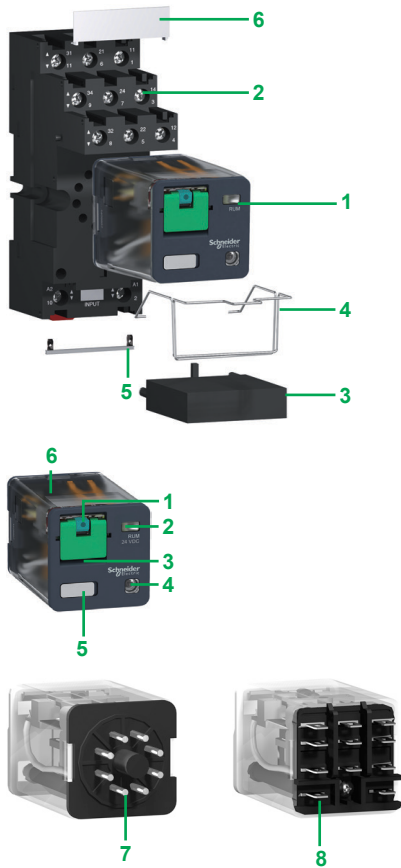

Presentation of the range

- The RUM universal relay range comprises:
- 10 A relays with 2 and 3 CO contacts, and cylindrical or flat (Faston type) pins (all these relays have the same dimensions)
 - Sockets with mixed or separate contact terminals
 - Protection modules (diode, RC circuit, or varistor) or 1 timer module, common to all RUM sockets
 - Metal maintaining clamp for all RUM sockets
 - 2-pole bus jumper that can be used on sockets with separate contact terminals in order to simplify cabling when creating an equipotential link between the coil terminals
 - Clip-in legends for the sockets

Relay description

- Spring-return pushbutton for testing the contacts (green: $\overline{\text{---}}$, red: \sim)
- Mechanical "relay status" indicator
- Removable lock-down door enabling forced maintaining of the contacts for test sequences or maintenance purposes (1)
- LED (depending on version) indicating the relay status
- Removable legend for relay identification
- Area by which the product can be easily gripped
- 8 or 11 cylindrical pins
- 8 or 11 flat (Faston type) pins

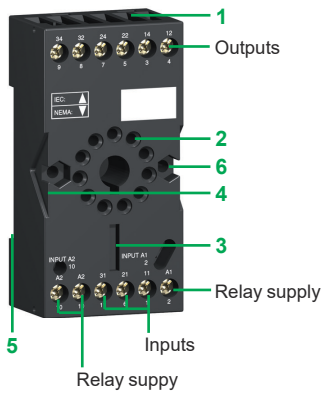

Socket description

Sockets with mixed contact terminals (2)

- Connection by screw connector
- 8 or 11 female contacts for the relay cylindrical pins
- Location for protection modules or the timer module
- Locking component for metal maintaining clamp
- A locating slot for mounting on DIN rail
- 2 holes for panel mounting

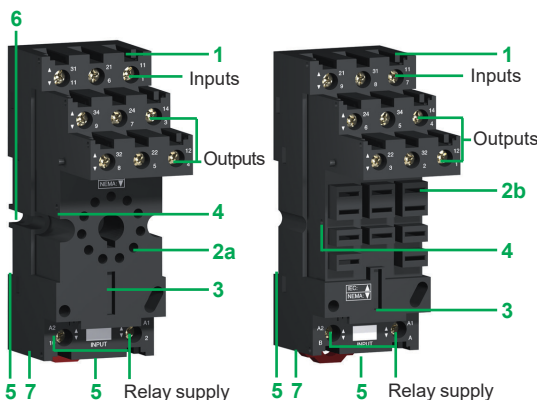

Sockets with separate contact terminals (3)

- Connection by screw connector
- a 8 or 11 female contacts for the relay cylindrical pins
b 11 female contacts for the relay flat pins
- Location for protection modules or the timer module
- Locking component for metal maintaining clamp
- Locating slot for mounting on DIN rail with mounting clip
- 2 holes for panel mounting
- Location for bus jumpers (see dimensions for mounting on sockets on www.schneider-electric.com)

(1) During operation, this lock-down door must always be in the closed position.
(2) The inputs are mixed with the relay supply, with the outputs being located on the opposite side of the socket.
(3) The inputs and outputs are separate from the relay supply.

Universal relays for customer assembly

Relays for standard applications, with lockable test button and without LED (sold in lots of 10)

Pins	Control circuit voltage	Number and type of contacts - Thermal current (Ith)			
		2 CO - 10 A		3 CO - 10 A	
		Unit reference	Weight	Unit reference	Weight
	V		kg/lb		kg/lb
Cylindrical	--- 12	RUMC21JD	0.086/0.190	RUMC31JD	0.086/0.190
	--- 24	RUMC21BD	0.086/0.190	RUMC31BD	0.086/0.190
	--- 48	RUMC21ED	0.086/0.190	RUMC31ED	0.086/0.190
	--- 60	–	–	RUMC31ND	0.086/0.190
	--- 110	RUMC21FD	0.086/0.190	RUMC31FD	0.086/0.190
	--- 125	–	–	RUMC31GD	0.086/0.190
	--- 220	–	–	RUMC31MD	0.086/0.190
	~ 24	RUMC21B7	0.086/0.190	RUMC31B7	0.086/0.190
	~ 48	RUMC21E7	0.086/0.190	RUMC31E7	0.086/0.190
	~ 120	RUMC21F7	0.086/0.190	RUMC31F7	0.086/0.190
~ 230	RUMC21P7	0.086/0.190	RUMC31P7	0.086/0.190	
Flat (Faston type)	--- 12	RUMF21JD	0.086/0.190	RUMF31JD	0.086/0.190
	--- 24	RUMF21BD	0.086/0.190	RUMF31BD	0.086/0.190
	--- 48	RUMF21ED	0.086/0.190	RUMF31ED	0.086/0.190
	--- 110	RUMF21FD	0.086/0.190	RUMF31FD	0.086/0.190
	~ 24	RUMF21B7	0.086/0.190	RUMF31B7	0.086/0.190
	~ 48	RUMF21E7	0.086/0.190	RUMF31E7	0.086/0.190
	~ 120	RUMF21F7	0.086/0.190	RUMF31F7	0.086/0.190
	~ 230	RUMF21P7	0.086/0.190	RUMF31P7	0.086/0.190

Relays for standard applications, with lockable test button and LED (sold in lots of 10)

Cylindrical	--- 12	RUMC22JD	0.086/0.190	RUMC32JD	0.086/0.190
	--- 24	RUMC22BD	0.086/0.190	RUMC32BD	0.086/0.190
	--- 48	RUMC22ED	0.086/0.190	RUMC32ED	0.086/0.190
	--- 60	–	–	RUMC32ND	0.086/0.190
	--- 110	RUMC22FD	0.086/0.190	RUMC32FD	0.086/0.190
	--- 125	–	–	RUMC32GD	0.086/0.190
	~ 24	RUMC22B7	0.086/0.190	RUMC32B7	0.086/0.190
	~ 48	RUMC22E7	0.086/0.190	RUMC32E7	0.086/0.190
	~ 120	RUMC22F7	0.086/0.190	RUMC32F7	0.086/0.190
	~ 230	RUMC22P7	0.086/0.190	RUMC32P7	0.086/0.190
Flat (Faston type)	--- 12	RUMF22JD	0.086/0.190	RUMF32JD	0.086/0.190
	--- 24	RUMF22BD	0.086/0.190	RUMF32BD	0.086/0.190
	--- 48	RUMF22ED	0.086/0.190	RUMF32ED	0.086/0.190
	--- 110	RUMF22FD	0.086/0.190	RUMF32FD	0.086/0.190
	~ 24	RUMF22B7	0.086/0.190	RUMF32B7	0.086/0.190
	~ 48	RUMF22E7	0.086/0.190	RUMF32E7	0.086/0.190
	~ 120	RUMF22F7	0.086/0.190	RUMF32F7	0.086/0.190
	~ 230	RUMF22P7	0.086/0.190	RUMF32P7	0.086/0.190



RUMC21BD



RUMC21F7



RUMC32BD



RUMF32F7

2

PF140739B



RUZSC3M +
Relay RUMC3●●●

PF108027



RUW241P7

PF516229



RUW101MW

Sockets

Contact terminal arrangement	Connection	Relay type	Sold in lots of	Unit reference	Weight kg/lb
Mixed	Screw connector	RUMC2●●●	10	RUZC2M	0.054/0.119
		RUMC3●●●	10	RUZC3M	0.054/0.119
Separate	Screw connector	RUMC2●●●	10	RUZSC2M	0.095/0.209
		RUMC3●●●	10	RUZSC3M	0.100/0.220
		RUMF2●●●	10	RUZSF3M	0.095/0.209
		RUMF3●●●			

Protection modules

Description	For use with	Voltage	Sold in lots of	Unit reference	Weight kg/lb
V					
Diode	All RUM sockets	--- 6...250	10	RUW240BD	0.004/0.009
RC circuit	All RUM sockets	~ 110...240	10	RUW241P7	0.004/0.009
Varistor	All RUM sockets	~/--- 24	10	RUW242B7	0.004/0.009
		~/--- 240	10	RUW242P7	0.004/0.009

Timer module

Description	For use with	Voltage	Reference	Weight kg/lb
V				
Multifunction	All RUM sockets	~/--- 24... 240	RUW101MW	0.020/0.044

Timing relays

Description	For use with	Reference	Weight kg/lb
2 timed CO contacts (single-function or multifunction)	RUZC●M sockets	RE48A●● (1)	—

(1) Please refer to "Zelio Time timing relays" catalog.

Accessories

Description	For use with	Sold in lots of	Unit reference	Weight kg/lb
Metal maintaining clamp	All RUM sockets	10	RUZC200	0.001/0.002
2-pole bus jumper (lth: 5 A)	All RUM sockets with separate contacts	10	RUZS2	0.005/0.011
Clip-in legends	All relays (sheet of 108 legends)	10	RXZL520	0.086/0.190
	All RUM sockets with separate contacts	10	RUZL420	0.001/0.002

DF5B6465



RUZC200

DF5B5203



RUZS2

2

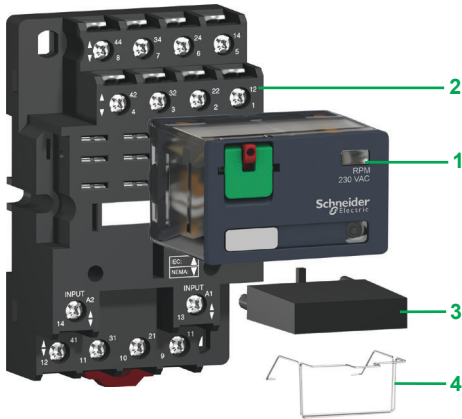

Presentation of the range

The RPM power relay range comprises:

- 1 15 A relay with 1, 2, 3, and 4 CO contacts
- 2 Sockets with mixed contact terminals
- 3 Protection modules (diode, RC circuit, or varistor) or 1 timer module (these protection modules are common to all sockets except for the timer module, which can be used on 3-pole or 4-pole sockets only)
- 4 Metal maintaining clamp for single-contact relays

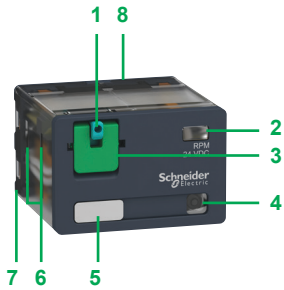

Relay description

- 1 Spring-return pushbutton for testing the contacts (green: $\overline{\text{---}}$, red: \sim)
- 2 Mechanical "relay status" indicator
- 3 Removable lock-down door enabling forced maintaining of the contacts for test sequences or maintenance purposes
- 4 LED (depending on version) indicating the relay status
- 5 Removable legend for relay identification
- 6 4 notches for rail mounting adapter or panel mounting adapter with mounting lugs
- 7 5, 8, 11, or 14 Faston type pins
- 8 Area by which the product can be easily gripped
- 9 Mounting adapter enabling direct mounting of the relay on a panel
- 10 Mounting adapter enabling direct mounting of the relay on a \perp rail

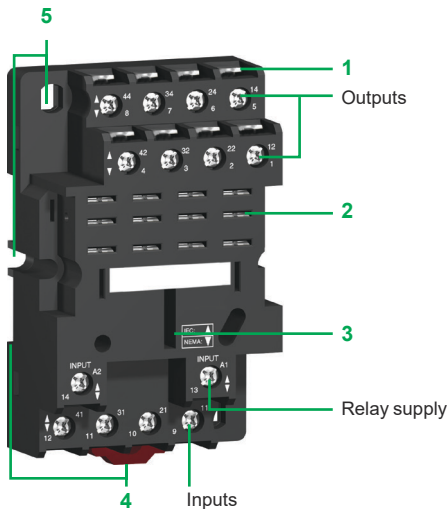
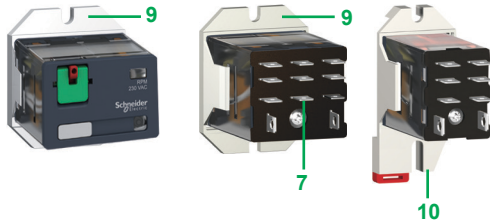

Socket description

Sockets with mixed contact terminals (1)

- 1 Connection by screw clamp terminals
- 2 5, 8, 11, or 14 female contacts for the relay pins
- 3 Location for protection modules or the timer module
- 4 Locating slot for mounting on rail with mounting clip
- 5 2 or 4 holes for panel mounting

(1) The inputs are mixed with the relay supply, with the outputs being located on the opposite side of the socket.



RPM41BD



RPM41P7



RPM42BD



RPM42P7

Power relays for customer assembly								
Power relays without LED (sold in lots of 10)								
Control circuit voltage	Number and type of contacts - Thermal current (Ith)				3 CO - 15 A		4 CO - 15 A	
	1 CO - 15 A	Weight	2 CO - 15 A	Weight	Unit reference	Weight	Unit reference	Weight
V	Unit reference	kg/lb	Unit reference	kg/lb	Unit reference	kg/lb	Unit reference	kg/lb
≡ 12	RPM11JD	0.026/0.057	RPM21JD	0.036/0.079	RPM31JD	0.054/0.119	RPM41JD	0.071/0.157
≡ 24	RPM11BD	0.026/0.057	RPM21BD	0.036/0.079	RPM31BD	0.054/0.119	RPM41BD	0.071/0.157
≡ 48	RPM11ED	0.026/0.057	RPM21ED	0.036/0.079	RPM31ED	0.054/0.119	RPM41ED	0.071/0.157
≡ 110	RPM11FD	0.026/0.057	RPM21FD	0.036/0.079	RPM31FD	0.054/0.119	RPM41FD	0.071/0.157
~ 24	RPM11B7	0.026/0.057	RPM21B7	0.036/0.079	RPM31B7	0.054/0.119	RPM41B7	0.071/0.157
~ 48	RPM11E7	0.026/0.057	RPM21E7	0.036/0.079	RPM31E7	0.054/0.119	RPM41E7	0.071/0.157
~ 120	RPM11F7	0.026/0.057	RPM21F7	0.036/0.079	RPM31F7	0.054/0.119	RPM41F7	0.071/0.157
~ 230	RPM11P7	0.026/0.057	RPM21P7	0.036/0.079	RPM31P7	0.054/0.119	RPM41P7	0.071/0.157
Power relays with LED (sold in lots of 10)								
≡ 12	RPM12JD	0.026/0.057	RPM22JD	0.036/0.079	RPM32JD	0.054/0.119	RPM42JD	0.071/0.157
≡ 24	RPM12BD	0.026/0.057	RPM22BD	0.036/0.079	RPM32BD	0.054/0.119	RPM42BD	0.071/0.157
≡ 48	RPM12ED	0.026/0.057	RPM22ED	0.036/0.079	RPM32ED	0.054/0.119	RPM42ED	0.071/0.157
≡ 110	RPM12FD	0.026/0.057	RPM22FD	0.036/0.079	RPM32FD	0.054/0.119	RPM42FD	0.071/0.157
~ 24	RPM12B7	0.026/0.057	RPM22B7	0.036/0.079	RPM32B7	0.054/0.119	RPM42B7	0.071/0.157
~ 48	RPM12E7	0.026/0.057	RPM22E7	0.036/0.079	RPM32E7	0.054/0.119	RPM42E7	0.071/0.157
~ 120	RPM12F7	0.026/0.057	RPM22F7	0.036/0.079	RPM32F7	0.054/0.119	RPM42F7	0.071/0.157
~ 230	RPM12P7	0.026/0.057	RPM22P7	0.036/0.079	RPM32P7	0.054/0.119	RPM42P7	0.071/0.157

PF142831B



RPZF4 + Relay RPM42P7

2

PF106044



RUW24●●●

Sockets

Contact terminal arrangement	Connection	Relay type	Sold in lots of	Unit reference	Weight kg/lb
Mixed	Screw clamp terminals	RPM1●●●	10	RPZF1	0.042/0.093
		RPM2●●●	10	RPZF2	0.054/0.119
		RPM3●●●	10	RPZF3	0.072/0.159
		RPM4●●●	10	RPZF4	0.094/0.207

Protection modules

Description	Voltage	Socket type	Sold in lots of	Unit reference	Weight kg/lb		
V							
Diode	~ 6...250	RPZF1	20	RXM040W	0.003/0.007		
		RPZF2	10	RUW240BD	0.004/0.009		
		RPZF3					
		RPZF4					
RC circuit	~ 24...60	RPZF1	20	RXM041BN7	0.010/0.022		
		RPZF2	20	RXM041FU7	0.010/0.022		
		RPZF1					
		RPZF2					
	~ 110...240	RPZF3	10	RUW241P7	0.004/0.009		
		RPZF4	20	RXM021RB	0.030/0.066		
		Varistor				~ 6...24	RPZF1
		~ 24...60				RPZF2	
~ 110...240	RPZF1						
~ 24	RPZF2						
Varistor	~ 24	RPZF3	10	RUW242B7	0.004/0.009		
		RPZF4	10	RUW242P7	0.004/0.009		
	~ 240	RPZF3					
	RPZF4						

Timer module (1)

Description	Voltage	Socket type	Reference	Weight
V				
Multifunction	~ 24... 240	RPZF3 RPZF4	RUW101MW	0.020/0.044

(1) See timer module description (selection of functions and time delays) on www.schneider-electric.com.

PF108045



RPZ1DA

PF108046



RPZ4FA

Accessories

Description	For use with	Sold in lots of	Unit reference	Weight kg/lb
Metal maintaining clamp (for single-pole relays)	RPZF1	20	RPZR235	0.001/0.002
Mounting adapters for $\underline{\text{L}}$ rail (1)	RPM1●●●	20	RPZ1DA	0.004/0.009
	RPM2●●●	20	RXZE2DA	0.004/0.009
	RPM3●●●	20	RPZ3DA	0.004/0.009
	RPM4●●●	20	RPZ4DA	0.006/0.013
Mounting adapters with panel mounting lugs	RPM1●●●	20	RPZ1FA	0.002/0.004
	RPM2●●●	20	RXZE2FA	0.002/0.004
	RPM3●●●	20	RPZ3FA	0.003/0.007
	RPM4●●●	20	RPZ4FA	0.004/0.009
Clip-in legends (sheet of 108 legends)	All relays	10	RXZL520	0.080/0.176
Clip-in legends (sheet of 16 legends)	All relays	10	RGZL520	0.080/0.176

(1) Test button becomes inaccessible.

Presentation of the range

RPF power relays with 2 CO or 2 NO contacts comprise:

- 1 4 or 6 Faston type pins
- 2 2 relay supply pins
- 3 Locating slot for mounting on DIN rail
- 4 2 holes for panel mounting

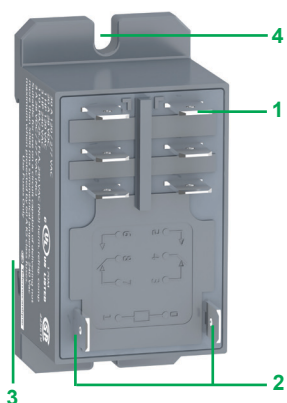

Zelio Relays - Electromechanical relays

Relays with clamp mounting
RPF power relays

RPF20361C



RPF2A●●

Power relays

Control circuit voltage	Sold in lots	Number and type of contacts - Thermal current (Ith)		Weight
		2 NO - 30 A (1) Unit reference	2 CO - 30 A (1) Unit reference	
V				kg/lb
⎓ 12	10	RPF2AJD	RPF2BJD	0.082/ 0.181
⎓ 24	10	RPF2ABD	RPF2BBD	0.082/ 0.181
~ 24	10	RPF2AB7	RPF2BB7	0.082/ 0.181
~ 120	10	RPF2AF7	RPF2BF7	0.082/ 0.181
~ 230	10	RPF2AP7	RPF2BP7	0.082/ 0.181

(1) 30 A when mounted with 13 mm (0.51 in.) gap between two relays and 25 A when mounted side by side without a gap.

Relays			
Contact types			
Symbol	Configuration	EU	USA
	Make contact (Normally Open)	NO	SPST-NO DPST-NO nPST-NO (1)
	Break contact (Normally Closed)	NC	SPST-NC DPST-NC nPST-NC (1)
	Changeover Contact	CO	SPDT DPDT nPDT (1)

Utilization categories		
Category	Type of current	Applications
AC-1	~ 1-phase ~ 3-phase	Resistive or slightly inductive loads
AC-3	~ 3-phase	Starting and braking of squirrel cage motors; reversing direction of rotation only after stopping of motor
AC-4	~ 3-phase	Starting of squirrel cage motors, inching; plugging, reversing direction of rotation
DC-1	---	Resistive or slightly inductive loads (2)
AC-14	~ 1-phase	Control of electromagnetic loads (< 72 VA), auxiliary control relays, power contactors, electromagnetic solenoid valves, and electromagnets
AC-15	~ 1-phase	Control of electromagnetic loads (> 72 VA), auxiliary control relays, power contactors, electromagnetic solenoid valves, and electromagnets
DC-13	---	Control of electromagnetic loads, auxiliary control relays, power contactors, magnetic solenoid valves, and electromagnets

Protection categories		
Category	Explanation	Condition
RT 0	Unenclosed relay	Relay not provided with a protective case
RT I	Dust protected relay	Relay provided with a case that helps to protect its mechanism from dust
RT II	Flux-proof relay	Relay capable of being automatically soldered without allowing the migration of solder fluxes beyond the intended areas
RT III	Wash-tight relay	Relay capable of being automatically soldered and then washed to remove flux residues and minimize the possibility of ingress of flux or washing solvents
RT IV	Sealed relay	Relay provided with a case that has no venting to the outside atmosphere
RT V	Hermetically sealed relay	Sealed relay with an enhanced level of sealing

(1) n = number of contacts.

(2) The switchable voltage can be doubled, for an equal current, by connecting 2 contacts in series.

Protection modules

Whenever an inductive load is de-energized (coil of a relay or of a contactor), an overvoltage appears at its terminals. This voltage peak can reach several thousand volts and a frequency of several MHz.

It is likely to disturb the operation of automation systems that contain electronic devices.

Protection modules are used to reduce the voltage peak on de-energization and therefore limit the energy of interference signals to a level that will not disturb surrounding coils and electronic devices.

These modules are used to help reduce the risk of:

- electromagnetic compatibility problems
- deterioration of contact materials
- damage to insulation due to overvoltage
- damage to electronic components

Diode protection module (with or without LED)

■ Advantages

- accumulation of energy allowing current to flow in the same direction
- absence of any voltage peaks at the coil terminals
- low cost

■ Disadvantages

- increase in relay drop-out time (3 to 4 times the usual time)
- no polarity protection
- de-energization of the relay

Protection module with varistor

■ Advantages

- can be used with \sim and --- supply
- voltage peak limited to about $2 U_n$
- little effect on relay drop-out time

■ Disadvantages

- no modification of coil's own oscillating frequency
- limitation of switching frequency

Protection module with RC circuit

■ Advantages

- coil oscillating frequency reduced to about 150 Hz
- voltage peak limited to $3 U_n$
- little effect on relay drop-out time

■ Disadvantages

- no protection for low voltages

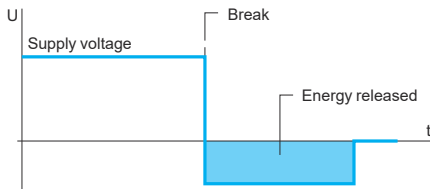

Coil voltage with diode protection module (--- only)

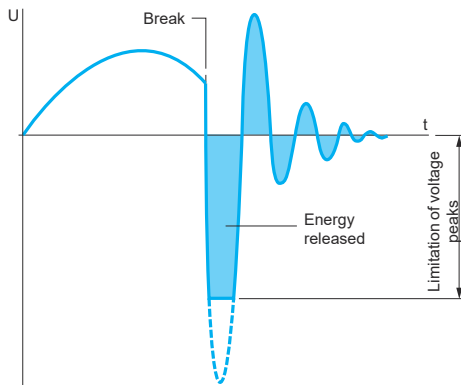

Coil voltage with varistor protection module (\sim and ---)

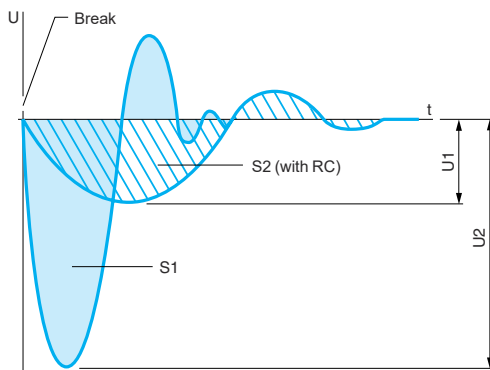

Coil voltage with RC circuit protection module (\sim only)

S1 = S2 = Energy released

Index

- Product reference index..... page 3/2



R	
RGZE1S35M	2/11
RGZE1S48M	2/11
RGZL520	2/11 2/23
RGZR215	2/11
RGZS08	2/7 2/11
RPF2AB7	2/25
RPF2ABD	2/25
RPF2AF7	2/25
RPF2AJD	2/25
RPF2AP7	2/25
RPF2BB7	2/25
RPF2BBD	2/25
RPF2BF7	2/25
RPF2BJD	2/25
RPF2BP7	2/25
RPM11B7	2/21
RPM11BD	2/21
RPM11E7	2/21
RPM11ED	2/21
RPM11F7	2/21
RPM11FD	2/21
RPM11JD	2/21
RPM11P7	2/21
RPM12B7	2/21
RPM12BD	2/21
RPM12E7	2/21
RPM12ED	2/21
RPM12F7	2/21
RPM12FD	2/21
RPM12JD	2/21
RPM12P7	2/21
RPM21B7	2/21
RPM21BD	2/21
RPM21E7	2/21
RPM21ED	2/21
RPM21F7	2/21
RPM21FD	2/21
RPM21JD	2/21
RPM21P7	2/21
RPM22B7	2/21
RPM22BD	2/21
RPM22E7	2/21
RPM22ED	2/21
RPM22F7	2/21
RPM22FD	2/21
RPM22JD	2/21
RPM22P7	2/21
RPM31B7	2/21
RPM31BD	2/21
RPM31E7	2/21
RPM31ED	2/21
RPM31F7	2/21
RPM31FD	2/21
RPM31JD	2/21
RPM31P7	2/21
RPM32B7	2/21
RPM32BD	2/21
RPM32E7	2/21
RPM32ED	2/21
RPM32F7	2/21
RPM32FD	2/21
RPM32JD	2/21
RPM32P7	2/21
RPM41B7	2/21
RPM41BD	2/21
RPM41E7	2/21
RPM41ED	2/21
RPM41F7	2/21
RPM41FD	2/21
RPM41JD	2/21
RPM41P7	2/21
RPM42B7	2/21
RPM42BD	2/21
RPM42E7	2/21
RPM42ED	2/21
RPM42F7	2/21
RPM42FD	2/21
RPM42JD	2/21
RPM42P7	2/21
RPZ1DA	2/23
RPZ1FA	2/23
RPZ3DA	2/23
RPZ3FA	2/23
RPZ4DA	2/23
RPZ4FA	2/23
RPZF1	2/22
RPZF2	2/22
RPZF3	2/22
RPZF4	2/22
RPZR235	2/23
RSB1A120B7	2/6
RSB1A120B7PV	2/5
RSB1A120BD	2/6
RSB1A120BDPV	2/5
RSB1A120E7	2/6
RSB1A120ED	2/6
RSB1A120F7	2/6
RSB1A120F7PV	2/5
RSB1A120FD	2/6
RSB1A120JD	2/6
RSB1A120JDPV	2/5
RSB1A120M7	2/6
RSB1A120ND	2/6
RSB1A120P7	2/6
RSB1A120P7PV	2/5
RSB1A120RD	2/6
RSB1A120U7	2/6
RSB1A160B7	2/6
RSB1A160BD	2/6
RSB1A160DPV	2/5
RSB1A160E7	2/6
RSB1A160ED	2/6
RSB1A160F7	2/6
RSB1A160FD	2/6
RSB1A160JD	2/6
RSB1A160M7	2/6
RSB1A160ND	2/6
RSB1A160P7	2/6
RSB1A160P7PV	2/5
RSB1A160RD	2/6
RSB1A160U7	2/6
RSB2A080B7	2/6
RSB2A080B7PV	2/5
RSB2A080BD	2/6
RSB2A080BDPV	2/5
RSB2A080E7	2/6
RSB2A080ED	2/6
RSB2A080F7	2/6
RSB2A080F7PV	2/5
RSB2A080FD	2/6
RSB2A080JD	2/6
RSB2A080JDPV	2/5
RSB2A080M7	2/6
RSB2A080M7PV	2/5
RSB2A080ND	2/6
RSB2A080P7	2/6
RSB2A080P7PV	2/5
RSB2A080RD	2/6
RSB2A080U7	2/6
RSL1AB4BD	2/3
RSL1AB4ED	2/3
RSL1AB4JD	2/3
RSL1AB4ND	2/3
RSL1GB4BD	2/3
RSL1GB4ED	2/3
RSL1GB4JD	2/3
RSL1GB4ND	2/3
RSL1PRBU	2/3
RSL1PREU	2/3
RSL1PRFU	2/3
RSL1PRJU	2/3
RSL1PRPU	2/3
RSL1PVBU	2/3
RSL1PVEU	2/3
RSL1PVFU	2/3
RSL1PVJU	2/3
RSL1PVPU	2/3
RSLZ2	2/3
RSLZ3	2/3
RSLZ5	2/3
RSLZRA1	2/3
RSLZRA2	2/3
RSLZRA3	2/3
RSLZRA4	2/3
RSLZVA1	2/3
RSLZVA2	2/3
RSLZVA3	2/3
RSLZVA4	2/3
RSZE1S35M	2/6
RSZE1S48M	2/6
RSZL300	2/7 2/11 2/15
RSZR215	2/7
RUMC21B7	2/17
RUMC21BD	2/17
RUMC21E7	2/17
RUMC21ED	2/17
RUMC21F7	2/17
RUMC21FD	2/17
RUMC21JD	2/17
RUMC21P7	2/17
RUMC22B7	2/17
RUMC22BD	2/17
RUMC22E7	2/17
RUMC22ED	2/17
RUMC22F7	2/17
RUMC22FD	2/17
RUMC22JD	2/17
RUMC22P7	2/17
RUMC31B7	2/17
RUMC31BD	2/17
RUMC31E7	2/17
RUMC31ED	2/17
RUMC31F7	2/17
RUMC31FD	2/17
RUMC31GD	2/17
RUMC31JD	2/17
RUMC31MD	2/17
RUMC31ND	2/17
RUMC31P7	2/17
RUMC32B7	2/17
RUMC32BD	2/17
RUMC32E7	2/17
RUMC32ED	2/17
RUMC32F7	2/17
RUMC32FD	2/17
RUMC32GD	2/17
RUMC32JD	2/17
RUMC32ND	2/17
RUMC32P7	2/17
RUMF21B7	2/17
RUMF21BD	2/17
RUMF21E7	2/17
RUMF21ED	2/17
RUMF21F7	2/17
RUMF21FD	2/17
RUMF21JD	2/17
RUMF21P7	2/17
RUMF22B7	2/17
RUMF22BD	2/17
RUMF22E7	2/17
RUMF22ED	2/17
RUMF22F7	2/17
RUMF22FD	2/17
RUMF22JD	2/17
RUMF22P7	2/17
RUMF31B7	2/17
RUMF31BD	2/17
RUMF31E7	2/17
RUMF31ED	2/17
RUMF31F7	2/17
RUMF31FD	2/17
RUMF31JD	2/17
RUMF31P7	2/17
RUMF32B7	2/17
RUMF32BD	2/17
RUMF32E7	2/17
RUMF32ED	2/17
RUMF32F7	2/17
RUMF32FD	2/17
RUMF32JD	2/17
RUMF32P7	2/17
RUW101MW	2/18 2/22
RUW240BD	2/18 2/22
RUW241P7	2/18 2/22
RUW242B7	2/18 2/22
RUW242P7	2/18 2/22
RUZC2M	2/18
RUZC3M	2/18
RUZC200	2/19
RUZL420	2/19
RUZS2	2/19
RUZSC2M	2/18
RUZSC3M	2/18
RUZSF3M	2/18
RXG11B7	2/9
RXG11BD	2/9
RXG11E7	2/9
RXG11ED	2/9
RXG11F7	2/9
RXG11FD	2/9
RXG11JD	2/9
RXG11M7	2/9
RXG11ND	2/9
RXG11P7	2/9
RXG11RD	2/9
RXG12B7	2/10
RXG12B7PV	2/9
RXG12BD	2/10
RXG12E7	2/10
RXG12ED	2/10
RXG12F7	2/10
RXG12FD	2/10
RXG12JD	2/10
RXG12M7	2/10
RXG12ND	2/10
RXG12P7	2/10
RXG12P7PV	2/9
RXG12RD	2/10
RXG13B7	2/10
RXG13BD	2/10
RXG13BDPV	2/9
RXG13E7	2/10
RXG13ED	2/10
RXG13F7	2/10
RXG13FD	2/10
RXG13JD	2/10
RXG13M7	2/10
RXG13ND	2/10
RXG13P7	2/10
RXG13P7PV	2/9
RXG13RD	2/10
RXG15B7	2/10
RXG15BD	2/10
RXG15E7	2/10
RXG15ED	2/10
RXG15F7	2/10
RXG15FD	2/10
RXG15JD	2/10
RXG15M7	2/10
RXG15ND	2/10
RXG15P7	2/10
RXG15RD	2/10
RXG21B7	2/9
RXG21B7PV	2/9
RXG21BD	2/9
RXG21BDPV	2/9
RXG21E7	2/9
RXG21ED	2/9
RXG21F7	2/9
RXG21FD	2/9
RXG21JD	2/9

RXG21M7	2/9	RXM2AB2P7PVS	2/13	RXM4GB2MD	2/14
RXG21ND	2/9	RXM3AB1B7	2/14	RXM4GB2ND	2/14
RXG21P7	2/9	RXM3AB1BD	2/14	RXM4GB2P7	2/14
RXG21P7PV	2/9	RXM3AB1E7	2/14	RXM4GB2U7	2/14
RXG21RD	2/9	RXM3AB1ED	2/14	RXM021BN	2/15 2/22
RXG22B7	2/10	RXM3AB1F7	2/14	RXM021FP	2/15 2/22
RXG22B7PV	2/9	RXM3AB1FD	2/14	RXM021RB	2/15 2/22
RXG22BD	2/10	RXM3AB1JD	2/14	RXM040W	2/15 2/22
RXG22BDPV	2/9	RXM3AB1P7	2/14	RXM041BN7	2/15 2/22
RXG22E7	2/10	RXM3AB2B7	2/14	RXM041FU7	2/15 2/22
RXG22ED	2/10	RXM3AB2BD	2/14	RXZ400	2/15
RXG22F7	2/10	RXM3AB2E7	2/14	RXZE2DA	2/15 2/23
RXG22FD	2/10	RXM3AB2ED	2/14	RXZE2FA	2/15 2/23
RXG22JD	2/10	RXM3AB2F7	2/14	RXZE2M114	2/15
RXG22M7	2/10	RXM3AB2FD	2/14	RXZE2M114M	2/15
RXG22ND	2/10	RXM3AB2JD	2/14	RXZE2S108M	2/15
RXG22P7	2/10	RXM3AB2P7	2/14	RXZE2S111M	2/15
RXG22P7PV	2/9	RXM4AB1B7	2/14	RXZE2S114M	2/15
RXG22RD	2/10	RXM4AB1B7PVM	2/13	RXZE2S114S	2/15
RXG23B7	2/10	RXM4AB1B7PVS	2/13	RXZL420	2/15
RXG23BD	2/10	RXM4AB1BD	2/14	RXZL520	2/15 2/19 2/23
RXG23BDPV	2/9	RXM4AB1BDPVM	2/13	RXZR335	2/15
RXG23E7	2/10	RXM4AB1BDPVS	2/13	RXZS2	2/15
RXG23ED	2/10	RXM4AB1E7	2/14	RZM021BN	2/6 2/11
RXG23F7	2/10	RXM4AB1ED	2/14	RZM021FP	2/6 2/11
RXG23FD	2/10	RXM4AB1F7	2/14	RZM021RB	2/6 2/11
RXG23JD	2/10	RXM4AB1FD	2/14	RZM031BN	2/6 2/11
RXG23M7	2/10	RXM4AB1JD	2/14	RZM031FPD	2/6 2/11
RXG23ND	2/10	RXM4AB1MD	2/14	RZM031RB	2/6 2/11
RXG23P7	2/10	RXM4AB1P7	2/14	RZM040W	2/6 2/11
RXG23P7PV	2/9	RXM4AB1P7PVM	2/13	RZM041BN7	2/6 2/11
RXG23RD	2/10	RXM4AB1P7PVS	2/13	RZM041FU7	2/6 2/11
RXG25B7	2/10	RXM4AB1U7	2/14		
RXG25BD	2/10	RXM4AB2B7	2/14		
RXG25E7	2/10	RXM4AB2B7PVM	2/13		
RXG25ED	2/10	RXM4AB2B7PVS	2/13		
RXG25F7	2/10	RXM4AB2BD	2/14		
RXG25FD	2/10	RXM4AB2BDPVM	2/13		
RXG25JD	2/10	RXM4AB2BDPVS	2/13		
RXG25M7	2/10	RXM4AB2E7	2/14		
RXG25ND	2/10	RXM4AB2ED	2/14		
RXG25P7	2/10	RXM4AB2F7	2/14		
RXG25RD	2/10	RXM4AB2FD	2/14		
RXM2AB1B7	2/14	RXM4AB2GD	2/14		
RXM2AB1BD	2/14	RXM4AB2JD	2/14		
RXM2AB1E7	2/14	RXM4AB2P7	2/14		
RXM2AB1ED	2/14	RXM4AB2P7PVM	2/13		
RXM2AB1F7	2/14	RXM4AB2P7PVS	2/13		
RXM2AB1FD	2/14	RXM4GB1B7	2/14		
RXM2AB1JD	2/14	RXM4GB1BD	2/14		
RXM2AB1P7	2/14	RXM4GB1E7	2/14		
RXM2AB2B7	2/14	RXM4GB1ED	2/14		
RXM2AB2B7PVM	2/13	RXM4GB1F7	2/14		
RXM2AB2B7PVS	2/13	RXM4GB1FD	2/14		
RXM2AB2BD	2/14	RXM4GB1JD	2/14		
RXM2AB2BDPVM	2/13	RXM4GB1P7	2/14		
RXM2AB2BDPVS	2/13	RXM4GB2B7	2/14		
RXM2AB2E7	2/14	RXM4GB2BD	2/14		
RXM2AB2ED	2/14	RXM4GB2E7	2/14		
RXM2AB2F7	2/14	RXM4GB2ED	2/14		
RXM2AB2FD	2/14	RXM4GB2F7	2/14		
RXM2AB2JD	2/14	RXM4GB2FD	2/14		
RXM2AB2P7	2/14	RXM4GB2GD	2/14		
RXM2AB2P7PVM	2/13	RXM4GB2JD	2/14		



www.schneider-electric.com/relays

Schneider Electric Industries SAS

Head Office
35, rue Joseph Monier
F-92500 Rueil-Malmaison
France

The information provided in this documentation contains general descriptions and/or technical characteristics of the performance of the products contained herein. This documentation is not intended as a substitute for and is not to be used for determining suitability or reliability of these products for specific user applications. It is the duty of any such user or integrator to perform the appropriate and complete risk analysis, evaluation and testing of the products with respect to the relevant specific application or use thereof. Neither Schneider Electric nor any of its affiliates or subsidiaries shall be responsible or liable for misuse of the information contained herein.

Design: Schneider Electric
Photos: Schneider Electric